

Operating instructions

Combi-Steam MSLQ

Combi-steam cooker

Thank you for choosing to buy one of our products. Your appliance is made to high standards and is easy to use. Nevertheless, please take the time to read these operating instructions in order to familiarise yourself with the appliance and get the best use out of it.

Please follow the safety precautions.

Modifications

Text, diagrams and data correspond to the technical standard of the appliance at the time these operating instructions went to press. The right to make technical modifications for the purpose of the further development of the appliance is reserved.

Validity

The product family (model number) corresponds to the first alphanumeric on the identification plate. These operating instructions apply to:

Type	Product family	Size system
CSTMSLQZ60	23015	60-600
CSTMSLQZ60c	23015	60-600

Variations depending on the model are noted in the text.

Colour operating instructions can be downloaded from the internet from www.vzug.com.

Table of contents

1	Safety precautions	5	5.6	Food probe temperature	26
1.1	Symbols used.....	5	5.7	Cancelling/ending the operating mode before time.....	27
1.2	General safety precautions.....	5	5.8	Changing the operating mode.....	27
1.3	Appliance-specific safety precautions	6	5.9	Timer	27
1.4	Instructions for use.....	8	5.10	End of operation	28
2	Using for the first time	11	5.11	Switching the appliance off.....	29
3	Appliance description	12	5.12	Emptying the water tank.....	30
3.1	Construction	12	6	Microwave	30
3.2	Operating and display elements.....	12	6.1	Note on use	30
3.3	Cooking space.....	13	6.2	Tips for microwave mode.....	31
3.4	Accessories	14	6.3	Microwave operation.....	31
3.5	Plate warmer.....	16	7	GourmetGuide	31
4	Operating modes	16	7.1	Recipe book	32
4.1	Overview of operating modes.....	16	7.2	Own recipes.....	33
4.2	Steam.....	16	7.3	Vacuisine *	35
4.3	Top/Bottom heat.....	17	7.4	BakeOmatic	37
4.4	Hot air	17	7.5	Professional baking.....	38
4.5	Hot air with steaming	17	7.6	Soft roasting.....	39
4.6	PowerSteam.....	18	7.7	RegenerateOmatic.....	42
4.7	PowerRegeneration.....	18	7.8	Defrosting.....	43
4.8	Microwave	18	7.9	Wellness *	43
4.9	Regeneration	19	7.10	Hygiene *	44
4.10	PizzaPlus	19	7.11	Keep warm *	44
4.11	Grill	20	8	EasyCook	44
4.12	Grill-forced convection.....	20	8.1	Overview of food groups.....	45
4.13	Top/Bottom heat humid	20	8.2	Selecting and starting foods.....	45
4.14	Hot air humid.....	21	9	Favourites	46
4.15	Bottom heat.....	21	9.1	Creating favourites	46
4.16	Fast heating	21	9.2	Selecting and starting favourites	46
4.17	Combi mode / PowerPlus.....	22	9.3	Changing favourites	46
5	Using the appliance	23	9.4	Deleting favourites.....	46
5.1	Filling the water tank	23	10	Tips and tricks	47
5.2	Selecting and starting the operating mode....	24	10.1	Unsatisfactory cooking result.....	47
5.3	Checking and changing the settings.....	24	10.2	General tips	48
5.4	Setting a duration	25	10.3	Saving energy.....	48
5.5	Setting a delayed start / end time.....	25			

11	User settings	48	15.3	Product fiche	64
11.1	Overview of user settings.....	48	15.4	EcoStandby.....	64
11.2	Adjusting user settings	48	15.5	Reference to «Open Source» licence.....	64
11.3	Language	49	16	Disposal	65
11.4	Display	49	17	Index	66
11.5	Date.....	49	18	Notes	69
11.6	Clock.....	50	19	Service & Support	71
11.7	Notifications	50			
11.8	Descaling the appliance.....	50			
11.9	Water hardness.....	50			
11.10	Loudness.....	51			
11.11	Assistance functions	51			
11.12	Temperature	51			
11.13	Childproof lock.....	52			
11.14	Appliance information.....	52			
11.15	Demo mode.....	52			
11.16	Checking the connection *	52			
11.17	Factory settings.....	52			
12	Care and maintenance	52			
12.1	Cleaning the exterior	53			
12.2	Cleaning the cooking space.....	53			
12.3	Cleaning the appliance door.....	53			
12.4	Cleaning the door seal	53			
12.5	Replacing the door seal	54			
12.6	Replacing the halogen light bulb	54			
12.7	Cleaning the accessories and shelf guides ...	54			
12.8	Descaling	54			
13	Trouble-shooting	57			
13.1	What to do if	57			
13.2	After a power failure.....	60			
14	Accessories and spare parts	61			
14.1	Accessories	62			
14.2	Special accessories	62			
14.3	Spare parts	62			
15	Technical data	63			
15.1	Note for testing institutes	63			
15.2	Temperature measurement	63			

1 Safety precautions

1.1 Symbols used



Denotes important safety precautions.

Failure to observe said precautions can result in injury or in damage to the appliance or fittings!



Information and precautions that should be observed.



Information on disposal



Information about the operating instructions

- ▶ Indicates step-by-step instructions.
 - Describes how the appliance reacts to the steps taken.
- Indicates a list.

1.2 General safety precautions



- Read the operating instructions before using the appliance for the first time!



- This appliance can be used by children aged 8 and above and by persons with reduced physical, sensory or mental capabilities, or lack of experience and/or knowledge, provided they are supervised or have been instructed on the safe use of the appliance and have understood the hazards involved. Children shall not play with the appliance. Cleaning and user maintenance shall not be undertaken by children without supervision.
- If an appliance is not equipped with a mains cable and a plug or other means for disconnecting from the mains with a contact opening on each pole complying with the conditions of overvoltage category III for full isolation, an isolating device must be incorporated into the perman-

ently installed electrical installation in accordance with the installation regulations.

- If the mains cable of this appliance is damaged, it must be replaced by the manufacturer or its Customer Services or a similarly qualified person in order to avoid hazard.

1.3 Appliance-specific safety precautions



- **READ THE IMPORTANT SAFETY PRECAUTIONS CAREFULLY AND RETAIN FOR FUTURE USE.**
- **WARNING:** The appliance and its accessible parts get hot during use. Be careful not to touch the heating elements. Children under 8 years of age must be kept away from the appliance unless they are constantly supervised.
- **WARNING:** Accessible parts can get hot during use. Keep young children away from the appliance.
- This appliance is intended for use in the home and similar settings such as: in staff kitchens in shops, offices and other commercial establishments; in agricultural establishments; by guests in hotels, motels and other accommodation establishments; in bed and breakfast establishments.
- A heatable appliance drawer and its contents get hot.
- Do not use aggressive or abrasive cleaning agents or sharp metal scrapers for cleaning the glass in the oven door as they could scratch the surface. This can destroy the glass.
- For appliances with pyrolytic self-cleaning: Excessive soiling and any and all accessories (tableware, baking trays, runners, shelf guides) must be removed before carrying out pyrolytic self-cleaning.
- Only use the food probe recommended for this oven.
- Under no circumstances use a steam cleaner to clean the appliance.
- **WARNING:** Before replacing the light bulb, ensure the appliance is switched off and disconnected from the mains power supply to avoid possible electric shock.
- To avoid overheating, the appliance must not be installed behind a decor door.
- This appliance is not intended for use in vehicles or on board ships or aircraft or in

rooms where there are special conditions such as, for instance, a corrosive or explosive atmosphere (dust, steam or gas) or condensing moisture.

- **WARNING:** Never heat food or liquids in sealed containers such as cans or bottles as they are liable to explode due to overpressure.
- See the «Accessories» section for the proper use of insertable parts.
- **WARNING:** Children should only use the appliance in the combined operating mode under adult supervision due to the temperatures generated.
- **WARNING:** In the event that the door or door seals are damaged, the appliance must not be used until it has been repaired by a qualified competent person.
- **WARNING:** It is hazardous for anyone other than a qualified competent person to carry out any service or repair operation which involves the removal of a cover which gives protection against exposure to microwave energy.
- Only use containers that are suitable for use with microwave appliances.
- The appliance must be constantly monitored when heating up foodstuffs in containers made from plastic or paper, as they could ignite.
- If smoke is observed, switch off or unplug the appliance and keep the appliance door closed in order to stifle any flames.
- The contents of feeding bottles and baby food jars must be stirred or shaken and the temperature must to be checked before consumption in order to avoid burns and scalds.
- The microwave appliance is intended for heating up food and beverages. Desiccating food, drying clothing or heating warming pads, slippers, sponges, damp cleaning cloths and the like can result in injury, ignition or fire.
- Microwave heating of beverages can result in delayed eruptive boiling (super boiling), therefore care must be taken when handling the container.
- Eggs in their shell or whole hard-boiled eggs should not be heated in microwave appliances since they may explode, even after microwave heating has ended.

- Keep the appliance and the door seals clean. Remove any soiling as soon as possible. Otherwise the appliance or the door seal could become damaged adversely affecting the life of the appliance and possibly result in a hazardous situation. For detailed information on cleaning the door seals, the cooking space and the adjacent parts, see the «Care and maintenance» section.
- Any repairs, modifications or manipulations to the appliance, especially any electrically live parts, may only be carried out by the manufacturer, its Customer Services or a similarly qualified person. Repairs if carried out incorrectly may cause serious injury, damage to the appliance and fittings, as well as affect the functioning of the appliance. If the appliance is not working properly or in case of a repair order, follow the instructions given in the «Service & Support» section. Please contact our Customer Services if necessary.
- Use original spare parts only.
- Retain these operating instructions for future reference.
- The appliance corresponds to recognized technology standards and the relevant safety regulations. Proper use of the appliance is essential to avoid damage and accidents. Please therefore follow the precautions given in these operating instructions.

1.4 Instructions for use

Before using for the first time

- The appliance must be installed and connected to the electricity supply in accordance with the separate installation instructions. Have a qualified fitter/ electrician carry out the necessary work.

Correct use

- The appliance is designed for use in the home for preparing food. Under no circumstances flambé or cook food using a lot of fat in the cooking space! No liability is assumed for any damage caused by improper use or incorrect handling.
- Never use the appliance to dry animals, textiles or paper, etc.
- Do not use the appliance as a room heater.
- The appliance should only be installed and operated at an ambient temperature of 5 °C to 35 °C. If frost develops, residual water left in the pumps could freeze and cause damage.
- Use the childproof locking facility.
- If the appliance is visibly damaged, do not use it. Contact our Customer Services.
- If the appliance is not operating properly, disconnect it from the power supply immediately.
- Ensure there are no foreign bodies or pets in the cooking space before closing the appliance door.
- Objects that could pose a danger if the appliance were accidentally switched on should not be stored in the cooking space or the heatable appliance drawer. Do not store food or any temperature-sensitive or inflammable materials, e.g. cleaning agents, oven sprays, etc., in the cooking space or the heatable appliance drawer.
- For appliances with grill: Leave the appliance door closed when grilling. The heat could otherwise damage the operating and display elements or the fitted units above.

- Do not switch the microwave on until you have put the food in the cooking space.
- Remove any non-microwaveable plastic and paper packaging from the food before cooking or defrosting it. Ignition hazard!
- Do not leave the appliance unattended when heating food in plastic or paper containers. Ignition hazard!
- Always open sealed food containers before placing them in the cooking space. Danger of explosion due to excess pressure!

Caution: Risk of burns!

- The appliance gets very hot when in use. The appliance door also gets hot.
- Steam and/or hot air may escape from the cooking space when the appliance door is opened.
- The appliance will remain hot for some time after it is switched off and will only cool down slowly to room temperature. Allow sufficient time for the appliance to cool down before, for instance, cleaning it.
- Overheated fat and oil can easily catch fire. Heating oil in the cooking space to sear meat is dangerous and should not be done. Never attempt to extinguish burning oil or fat with water. Danger of explosion! Smother the flames with a fire blanket. Keep doors and windows closed.
- Do not pour spirits (brandy, whisky, schnapps, etc.) over hot food. Danger of explosion!
- Do not leave the appliance unattended when drying herbs, bread, mushrooms, etc. If the foodstuff dries out too much, it can pose a fire hazard.
- If you notice smoke possibly coming from the appliance itself or from inside the cooking space, keep the appliance door closed. Disconnect the appliance from the power supply.
- Accessories get hot in the cooking space. Use protective gloves or oven cloths.

- Do not heat up alcoholic beverages!
- When heating liquids in a microwave, place a teaspoon in the vessel to prevent delayed boiling. When delayed boiling occurs, the boiling temperature is reached without the usual steam bubbles rising. Disturbing a vessel, even slightly, can cause the liquid to erupt if the container is open. Do not use vessels with a narrow lip.

Caution: Risk of injury!

- Be careful not to put fingers in the door hinges, there is otherwise a risk of injury if the appliance door is moved. Particular care should be taken when children are around.
- Only leave the appliance door open in the at-rest position. An open appliance door poses a danger of tripping or injury! Do not sit or rest on the appliance door or use it as a storage surface.
- For hobs: A hob guard can be fitted to protect small children. Hob guards are available from specialist retailers.

Caution: Risk to life!

- Danger of suffocation! Keep packaging material, e.g. plastic film and polystyrene, away from children. Packaging material can be dangerous for children.

How to avoid damaging the appliance

- Close the appliance door carefully.
- For appliances with visible bottom heating element: Do not place any objects directly on the bottom heating element.
- Do not use protective aluminium inserts with appliances with no visible bottom heating element.
- Do not use objects that can rust in the cooking space.
- Using knives or cutting wheels on the baking tray will visibly damage the surface.
- To prevent corrosion, leave the appliance door open in the at-rest position until the cooking space has cooled down.

1 Safety precautions

- When cleaning the appliance, make sure no water gets inside it. Use a moderately damp cloth. Do not spray the outside or the inside of the appliance with water. If water gets inside the appliance, it will cause damage.
- The construction of the appliance may not be changed in any way. Do not apply force to or interfere with the appliance door or the control and safety devices. The illumination may only be replaced by our Customer Services.
- Take care not to damage the appliance door, the door frame and the door hinges.
- Ensure that nothing is trapped between the appliance door and the frame.
- Do not switch the microwave on until you have put the food in the cooking space.

2 Using for the first time

Before operating the newly installed appliance for the first time, the following steps should be taken:

- ▶ Remove packaging and transport materials as well as any protective blue film from out of the cooking space.
- ▶ Clean the cooking space and the accessories.
- ▶ Press the power button.
 - The appliance switches on.

Version 1 *

* Depending on the software version

- Various user settings necessary for operation, such as language, time and temperature unit, appear in the display one after the other.
- ▶ Make the settings and confirm.
- ▶ Fill the water tank with fresh, cold drinking water and slot into position in the water tank compartment.



Language and time must be set so that the appliance can be operated.

Version 2 *

* Depending on the software version

- ▶ Set the time (see page 50).
- ▶ If necessary, adjust the user settings to the water hardness (see page 50).
- ▶ Fill the water tank with fresh, cold drinking water and slot into position in the water tank compartment.

Completing the initial set-up

- ▶ Heat the empty cooking space (without wire shelves, baking trays, etc.) using the  operating mode at 180 °C for about 30 minutes.



As there is likely to be some smoke and odour given off, we recommend ventilating the room well during this phase.



All temperatures in these operating instructions are in degrees Celsius. Apply the corresponding conversions via the user setting «Degrees Fahrenheit» (see page 51).

3 Appliance description

3.1 Construction

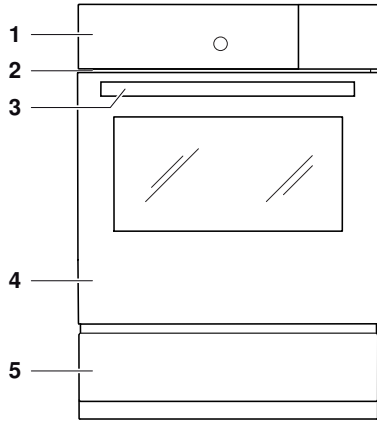

- 1 Operating and display elements
 - 2 Ventilation opening
 - 3 Door handle
 - 4 Appliance door
 - 5 Heatable appliance drawer *
- * Depending on model

3.2 Operating and display elements

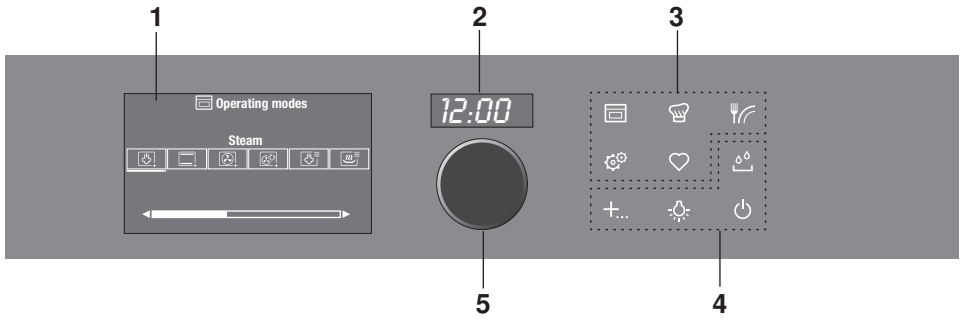

- 1 Display
- 2 Digital display (duration/timer/time)
- 3 Menu buttons
- 4 Action buttons
- 5 Adjusting knob / switching on appliance

Overview of touch buttons

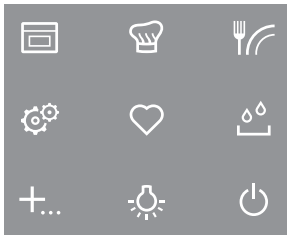

	Operating modes
	GourmetGuide
	EasyCook
	User settings
	Favourites
	Water tank
	Extra functions
	Cooking space illumination
	Switch off

3.3 Cooking space



Using protective inserts or aluminium foil can damage the appliance.

Do not place any protective insert or aluminium foil on the floor of the cooking space.

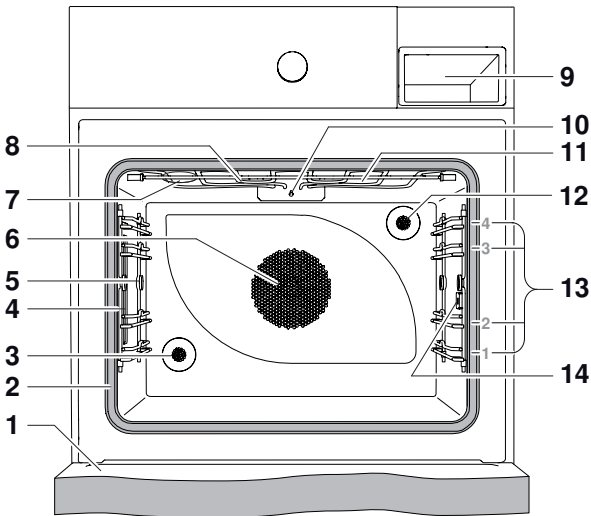

1	Appliance door	8	Grill/top heat
2	Door seal	9	Water tank compartment
3	Climate sensor	10	Temperature sensor
4	Cooking space illumination	11	Microwave inlet
5	Knurled nut	12	Steam inlet
6	Hot air blower	13	Levels
7	Cooking space ventilation	14	Socket for food probe



The bottom heating element is beneath the cooking space floor.

3.4 Accessories



Incorrect handling can cause damage!





Do not use knives or cutting wheels on the accessories.



Do not use any metal accessories in the microwave and combi modes nor any baking tray or stainless steel tray.

Dual enamel baking tray



- Baking tin e.g. for flans, bread and biscuits
- Use together with the wire shelf as a drip tray.
- If not fully covered by the baking, its shape can become distorted during baking. This is normal. As it cools down, it will go back to its original form.
- Not suitable for use with the ,  and  operating modes.
 - ▶ Instead use the stainless steel tray.
- Not suitable for use with the  and  operating modes if the temperature is set to under 150 °C. With frequent use, the appearance of the surface can change. However, this does not affect the functionality.



Do not use the baking tray in the microwave and combi modes.



1



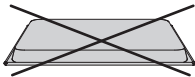

- ▶ Ensure that the «sloped» side **1** of the baking tray is to the back of the cooking space.

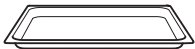

- ▶ Only use the normal way round – not upside down.

Stainless steel tray



- Use together with the wire shelf or perforated cooking tray as a drip tray.
- Baking tin e.g. for aperitif nibbles and biscuits
- If not fully covered by the baking, its shape can become distorted during baking. This is normal. As it cools down, it will go back to its original form.
- Less suitable for use with the  and  operating modes if the temperature is set to over 150 °C.
- Not suitable for use with the  and  operating modes.
 - ▶ Only use the normal way round – not upside down.

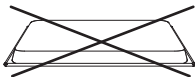



Perforated plastic cooking tray



- Particularly suitable for use in the microwave and combi mode
- For cooking fresh or frozen vegetables, meat and fish
- For extracting juice from berries, fruit, etc.

► Do not use metal cutlery (knives, ladles, etc.) for preparing or serving. Metal leaves traces of use.



Not suitable for use with the  and  operating modes, GourmetGuide applications with grill nor for temperatures of over 150 °C. There must be a distance between the cooking tray and the floor and roof of the cooking space of at least 5 cm.

Wire shelf



Using the wrong accessories can damage the appliance!

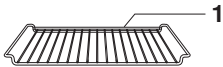

- For standing roasting and baking tins on
- For standing meat, frozen pizza, etc. on
- Ensure that the cross strut **1** is to the back of the cooking space. It enables the food to be removed safely from the cooking space.
- Serves as a cooling rack

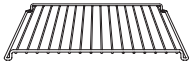

Hardened glass dish



Cooling the glass dish too quickly can cause stress cracks or fractures.

Allow the glass dish when it is hot to cool down slowly – do not put it on a cold surface or cool it down with water.



- Especially for use in the microwave and combi modes
- For standing baking tins, ramekins, preserving jars, etc. on
- For standing the perforated cooking tray on
- Use when grilling or together with the perforated cooking tray as a drip tray.

Food probe



- For measuring the core temperature of food



For recommended food probe temperatures, see «EasyCook».



Not suitable for temperatures of over 230 °C. There must be a distance between the food probe and the roof of the cooking space of at least 5 cm.

Special accessories

 Place any accessories not included in the scope of delivery on the wire shelf or, for operating modes with microwave, on the glass dish.

► Special accessories can be found at: www.vzug.com

3.5 Plate warmer

- If the appliance is switched off, first press the adjusting knob.
- Put the wire shelf at level 1 and place the tableware on it.
- Press the **+**... touch button.
- Select .
- Set the required duration.

 Select a duration of at least 1 hour.

- Set the end time if necessary.
- Switch on the «Plate warmer» by selecting ►.
 - The «Plate warmer» switches off automatically when the set duration is over.

4 Operating modes

4.1 Overview of operating modes

 Do not use any metal accessories in the microwave and combi modes nor any baking tray or stainless steel tray.

All the operating modes and fast heating are described below.

 Follow the advice given in «Tips and tricks» (see page 47) and in «EasyCook».

4.2 Steam



Temperature range	30–100 °C
Recommended value	100 °C
Level	1 to 4

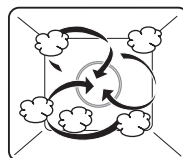

The cooking space is heated simultaneously by steam and hot air. The food is heated up or cooked by steaming.

Uses

- Cooking vegetables, rice, cereal products, pulses and egg dishes
- Poaching meat, poultry and fish
- Extracting juice from fruit and berries
- Making yoghurt
- Preserving

 Possible to cook on several levels simultaneously.

- Place the stainless steel tray underneath the perforated cooking tray.

4.3 Top/Bottom heat



Temperature range	30–230 °C
Recommended value	200 °C
Level	2 (or 1)

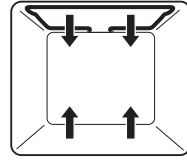

The cooking space is heated by the top and bottom heating elements.

Uses

- Classic operating mode for cooking and baking on one level
- Cakes, biscuits, bread and roasts



Use a dark enamelled tray or a black tray or tin for crispy results.

4.4 Hot air



Temperature range	30–230 °C
Recommended value	180 °C
Level	2 or 1 + 3

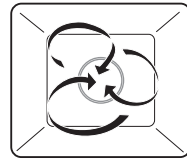

A heating element behind the back wall of the cooking space heats up the air inside the cooking space, which is circulated evenly.

Uses

- Particularly suitable for baking savouries and biscuits on several levels at the same time
- Cakes, bread and roasts



Select a lower temperature (reduce by approximately 20 °C) than for  as the heat transfer is more efficient.

4.5 Hot air with steaming



Temperature range	80–230 °C
Recommended value	180 °C
Level	2 or 1 + 3



A heating element behind the back wall of the cooking space heats up the air inside the cooking space, which is circulated evenly. With condensing steam, the energy is transferred more efficiently to the food than when cooking with hot air, which accelerates the cooking process.

Steam over 100° C is not visible.



Uses

- Puff pastries, yeast pastries, bread, plaited bread
- Baked dishes and gratins
- Meat
- Frozen and convenience foods



Particularly suitable for low-fat cooking of frozen foods such as oven chips and spring rolls.

The supply of steam can be switched off and on again during operation.

- ▶ Start the operating mode.
- ▶ To switch off the supply of steam, select  «Switch steaming off» in the settings of the operating mode.
 - The  symbol goes out.
- ▶ To switch the supply of steam on again, select  «Switch steaming on».
 - The  symbol illuminates.

4.6 PowerSteam



Level 2

The cooking time is reduced as the food is microwaved as well as steamed.

Uses

- Cooking vegetables, rice, cereal products and pulses



Refer to the recommended cooking times in «EasyCook».

4.7 PowerRegeneration



Level 2

Heating with steam and hot air cooks the food gently without drying it out. The additional, automatic microwave power shortens the reheating time.

Uses

- Reheating precooked foods and convenience foods

4.8 Microwave



Power range in steps from 50–700 W

Recommended value 500 W / 2 mins.

Level 2

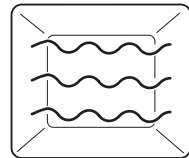

Foods and liquids are heated using microwaves.

Uses

- Precooked foods

- Frozen and convenience foods
- Liquids

Preparing eggs:

- ▶ Crack open the eggs and beat them before cooking.
- ▶ For fried eggs: Prick the yolk before cooking



- ▶ Turn or stir foods, if possible, halfway through the cooking time.



Use a fork to prick the skin or peel of foods such as potatoes, tomatoes, sausages, shellfish or similar.

Otherwise, the steam that is produced will be unable to escape and may cause the food to explode.



Further information on the microwave can be found in the «Microwave» section (see page 30).

4.9 Regeneration



Temperature range

80–200 °C

Recommended value

120 °C

Level

2 or 1 + 3

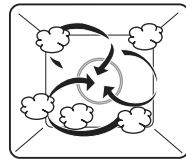

The cooking space is heated by steam and hot air. The food is reheated gently without drying it out.

Uses

- Reheating precooked foods and convenience foods



Possible to regenerate on several levels simultaneously.

4.10 PizzaPlus



Temperature range

30–230 °C

Recommended value

180 °C

Level

2 (or 1)

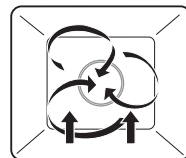

The cooking space is heated by hot air and bottom heat. The base of the food is baked particularly intensively.

Uses

- Pizza
- Flans and quiches



Use a dark enamelled tray or a black tray or tin without baking paper for very crispy results.

4.11 Grill



Temperature range	4 levels
Recommended value	Level 3
Level	3 or 4

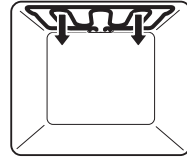

The cooking space is heated by the grill element.

Uses

- Flat food for grilling, e.g. steaks, chops, chicken parts, fish and sausages
- Gratinating
- Toast
- ▶ Place the food to be grilled directly on the wire shelf.
- ▶ Line the baking tray with aluminium foil and then place it underneath the wire shelf.



For best results, preheat the cooking space for 3 minutes before introducing the food.

4.12 Grill-forced convection



Temperature range	30–230 °C
Recommended value	180 °C
Level	2 or 3

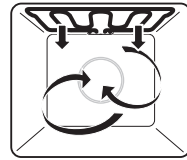

The cooking space is heated by the grill element. The hot air fan distributes the air evenly in the cooking space.

Uses

- Suitable for a whole chicken
- Large, bulky food for grilling
- ▶ Put food for grilling in a porcelain or glass dish or directly on the wire shelf.
- ▶ Line the baking tray with aluminium foil and then place it underneath the wire shelf.

4.13 Top/Bottom heat humid



Temperature range	30–230 °C
Recommended value	200 °C
Level	2 (or 1)

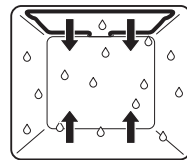

The cooking space is heated by the top and bottom heating elements. The steam produced is largely retained in the cooking space. The food retains its moisture.

Uses

- Bread, plaited bread, roasts and gratins on one level
- Low temperature cooking

4.14 Hot air humid



Temperature range	30–230 °C
Recommended value	180 °C
Level	2 or 1 + 3

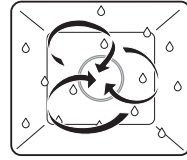

A heating element behind the back wall of the cooking space heats up the air inside the cooking space, which is circulated evenly. The steam produced is largely retained in the cooking space. The food retains its moisture.

Uses

- For savouries and biscuits on two levels at the same time
- For yeast pastries and bread on two levels at the same time
- Gratins and baked dishes



Select a lower temperature (reduce by approximately 20 °C) than for  as the heat transfer is more efficient.

4.15 Bottom heat



Temperature range	6 levels
Recommended value	Level 3
Level	2 (or 1)

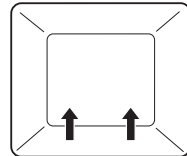

The cooking space is heated by the bottom heating element.

Uses

- Baking flan bases
- Making preserves







Use a dark enamelled tray or a black tray or tin for crispy results.

4.16 Fast heating

For fast heating , the cooking space is heated using hot air and bottom heat, which shortens the preheating time. Fast heating can be used with the following operating

modes:  and .

- ▶ Select the desired operating mode and adjust the settings.
- ▶ To start the operating mode, select .
- ▶ Select  «Switch fast heating on» in the settings for the operating mode.
 - Above , the  symbol illuminates.

As soon as an acoustic signal is emitted:

- put the food into the cooking space.

4.17 Combi mode / PowerPlus



Check the food from time to time during operation so that it does not burn.

Switch the combi mode off if necessary.

Thanks to PowerPlus, cooking times can be reduced as any operating mode can be combined with the microwave. Every PowerPlus level is assigned a total amount of energy that is delivered to the food over a set duration. The duration of the operating mode is not important: any residual energy dissipates when the cooking time is up. PowerPlus can be turned on before starting the operating mode or while it is running.

- ▶ Select in the settings of the current operating mode.
- ▶ Set the desired PowerPlus level and confirm.



When using the food probe, the appliance switches off when the food probe temperature is reached.

PowerPlus ends during operation

If PowerPlus ends during operation, a new PowerPlus level can be set subsequently.

Changing PowerPlus during operation

- ▶ Select in the settings of the current operating mode.
- ▶ Set PowerPlus to level **X** and confirm.
 - The current PowerPlus level ends.
 - The operating mode settings are displayed.
- ▶ Select again.
- ▶ Select a new PowerPlus level and confirm.

Overview of the PowerPlus levels

Intensity	Output	Uses, e.g.
Gentle	100–200 W	Baking cakes, braising/roasting meat
Moderate	300–400 W	Cooking foods with fillings or gratins with little topping/liquid
Intensive	500 W	Cooking gratins / baked dishes with a lot of topping/liquid
Extra intensive	600 W	Cooking gratins / baked dishes with a lot of topping/liquid

Duration	Minutes	Uses, e.g.
Short	Up to 10 mins.	Baking quick cakes, cooking delicate or low water content foods
Medium	10–20 mins.	Cooking gratins / baked dishes
Long	Over 20 mins.	Baking cakes, braising/roasting meat







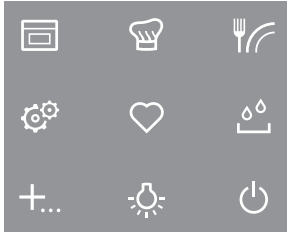

5 Using the appliance

The different main menus and functions are selected by pressing the corresponding touch button. Selected touch buttons and functions are illuminated in white; other selectable functions are illuminated in orange.

Settings and functions that cannot be selected or changed are greyed out in the various menus.

The following touch buttons with the following main menus and functions are available:



	Operating modes
	GourmetGuide
	EasyCook
	User settings
	Favourites
	Water tank
	Extra functions
	Cooking space illumination
	Switch off

Adjusting knob functions

- | | |
|-------|--|
| Press | <ul style="list-style-type: none"> ▪ Switching on the appliance ▪ Selecting/opening a submenu, setting, etc. ▪ Confirming/closing a message ▪ Activating/deactivating a user setting |
| Turn | <ul style="list-style-type: none"> ▪ Navigating within the submenus ▪ Changing/setting a value, user setting |



Your appliance has a touch function display. You can also select submenus, confirm messages and activate/deactivate user settings by pressing the relevant part of the display.

5.1 Filling the water tank



Do not use demineralized (filtered) or distilled water.

- ▶ If the appliance is switched off: first press the adjusting knob.
- ▶ Press the  touch button.
 - The water tank is ejected.
- ▶ Remove the water tank to fill it.
- ▶ Fill the water tank with fresh, cold drinking water and seal it with the cover.
- ▶ Slot the filled water tank into position in the water tank compartment.

Refill water

The contents of the water tank normally suffice for one cooking session. If, however, the water tank needs to be refilled:

- ▶ Fill the water tank with a maximum of 0.5 l of water as otherwise water could spill over at the end of operation.

5.2 Selecting and starting the operating mode

- ▶ If the appliance is switched off: first press the adjusting knob.
- ▶ If the appliance is in another menu: press the  touch button.
 - The selection of operating modes appears in the display.
- ▶ Select the operating mode.
 - The operating mode settings appear in the display; a recommended value appears above the temperature.
- ▶ Set the values for duration, end time, temperature or temperature level, PowerPlus level and target temperature as required and confirm.

Press and go

Once all the necessary settings for the operating mode have been made, a bar appears in the display and counts down 20 seconds. If no further settings are made during this time, operation starts automatically. If a setting is changed, Press and go starts again.



The duration of Press and go can be adjusted (see page 51) or it can be deactivated in the user settings.

- ▶ To start operation immediately, i.e. without Press and go, select ▶.
 - If set, the countdown to the time remaining appears in the display and in the digital display.



The operating mode selected cannot be changed once it has started.

Display overview

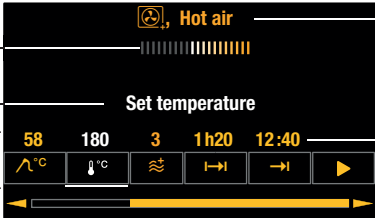

The screenshot shows the appliance's control panel with the following elements labeled:

- 1: A bracket on the left side of the bottom row of icons.
- 2: The text "Set temperature" above the temperature and duration values.
- 3: A horizontal bar at the top of the display.
- 4: The text "Hot air" next to a fan icon.
- 5: The numerical values "58", "180", "3", "1h20", and "12:40" displayed in the bottom row.
- 6: The navigation icons (up, down, left, right, and play) in the bottom row.

5.3 Checking and changing the settings

- ▶ Select the symbol for the desired setting.
- ▶ To change the value, turn the adjusting knob to the right or left.
- ▶ Press the adjusting knob to confirm the setting.
 - The operating mode settings are displayed.
 - The changed value can be seen above the corresponding symbol.



The end time can only be changed during the first 60 seconds of operation.

5.4 Setting a duration

The operating mode selected ends automatically when the operating time is up.

- ▶ Select the desired operating mode.
- ▶ Select  in the operating mode settings.
- ▶ Set the desired duration – max. 9 hours and 59 minutes – and confirm.
 - The duration is displayed in the operating mode settings as well as the end time which is calculated based on this value.
 - End of operation / duration finished (see page 28)

5.5 Setting a delayed start / end time

The delayed start is activated when for the operating mode selected both the duration and the end time are set.

The appliance switches automatically on and off again at the desired times.

If you use the food probe, you will need to estimate and set the duration. You will find a guide on times in «EasyCook». The appliance switches on with a delay and switches off again when the set target temperature is reached. Depending on the estimated duration, this can occur earlier or later than the set end time.





Perishables should not be kept unrefrigerated.

Before setting the delayed start

- ▶ Place the food in the cooking space.
- ▶ Select the desired operating mode.
- ▶ Set the temperature.
- ▶ Set the duration.

Setting a delayed start

- ▶ Select  in the operating mode settings.
 - The current end time calculated using the duration is displayed.
- ▶ Set the desired end and confirm.
 - The time remaining to the start of operation is displayed.
 - After 3 minutes, the display goes out and the  touch button is illuminated in white. The display can be called up again at any time by pressing the adjusting knob.
 - The appliance remains switched off until 3 minutes before the automatic start of operation.
- ▶ Check and change the settings (see page 24).

Example

- ▶ Select the  operating mode and 180°C.
- ▶ At 8:00, set a duration of 1 hour and 15 minutes.
- ▶ Set the end time to 11:30.
 - The appliance will automatically switch on at 10:15 and off again at 11:30.

5.6 Food probe temperature



Only use the supplied food probe.

Do not clean the food probe in the dishwasher. Always keep the plug clean.

The food probe is used to measure the temperature inside the food (referred to as the **food probe temperature**). As soon as the food reaches the **target temperature** (the food probe temperature that should be attained at the end of the cooking process), operation stops automatically. It is also possible to simply measure the food probe temperature without stopping operation.



The food probe must be inserted as far into the middle of the meat as possible to get a correct reading of the food probe temperature.

The optimal target temperature is dependent on the cut of meat and on the degree of doneness.

Refer to the information on target temperatures in «EasyCook».

Setting

- ▶ Select the desired operating mode and set the temperature.
- ▶ Select A°C in the operating mode settings.
- ▶ Set the desired target temperature and confirm.
- ▶ To start operation, select ▶.



Operation can only be started when the food probe is plugged in.

- ▶ Check and change the settings (see page 24).
 - The current food probe temperature is shown in the top part of the display when cooking.
 - The set target temperature is displayed above A°C .
 - Operation ends automatically once the target temperature has been reached – see also End of operation (see page 28).







If the meat is left in the cooking space after having switched off the appliance, the food probe temperature will continue to rise due to the residual heat.

Measuring the food probe temperature



If you only wish to measure the food probe temperature without operation stopping automatically when the target temperature is reached, proceed as follows:

- ▶ Select the desired operating mode and set the temperature and, if you wish, the duration.
- ▶ Plug in the food probe.
- ▶ Start the operating mode.
 - The current food probe temperature is shown in the top part of the display when cooking.

5.7 Cancelling/ending the operating mode before time

- ▶ In the operating mode settings, select  or press the  touch button.
 - An acoustic signal is emitted.
 - The selected operating mode is cancelled.
 - The following appears in the display: « Residual heat» and, for example: « Hot air cancelled».
 - If the food probe is plugged in, the food probe temperature is displayed. *

* Depending on the software version



- ▶ If you wish to start a new operating mode, press the  touch button.
- ▶ If you wish to switch off the appliance, press the  touch button.

5.8 Changing the operating mode

If no operating mode is running:

- ▶ Select  in the settings of the current operating mode.
 - The operating modes menu is displayed.



If an operating mode is already running:

- ▶ Select  or press the  touch button.
 - The set operating mode is cancelled.
- ▶ Press the  touch button and select a new operating mode.

5.9 Timer

The timer functions like an egg timer. It can be used at any time and independently of all other functions.

Setting and starting the timer

- ▶ Press the ... touch button.
- ▶ Select .
 - A suggested value of «10min» appears in the display.
- ▶ Turn the adjusting knob and set the desired duration.
 - The duration and the end time for the timer appear in the display.

The timer can be set for:

- up to 10 minutes in 10-second intervals, e.g. = 9 minutes and 50 seconds;
- over 10 minutes in 1-minute intervals, e.g. = 1 hour and 12 minutes;
- over 10 hours in 1-hour intervals, e.g. = 18 hours.

The maximum timer duration is 99 hours.

- ▶ Press the adjusting knob to confirm.
 - The timer starts.
 - If there is no operating mode running with a set duration, the remaining time on the timer will be displayed in the digital display.
 - The ... touch button is illuminated in white.
 - If the appliance was in another menu before the timer was set, e.g. operating modes: the menu or the submenu selected within it, e.g. a running operating mode, appears.
 - If the appliance was not in another menu: the display goes black.

Checking and changing

- ▶ Press the **+**... touch button.
- ▶ Select .
 - The countdown to the time remaining appears in the display.
- ▶ Shorten or extend the time by turning the adjusting knob.
- ▶ Confirm this shortening or extending of the time.

When the timer finishes

When the set duration is up:

- An acoustic signal is emitted.
- «Timer finished» appears in the display.
- ▶ To close the message, select .

Switching the timer off before time

- ▶ Press the **+**... touch button.
- ▶ Select .
 - The countdown to the time remaining appears in the display.
- ▶ Set the timer to 0 by turning the adjusting knob and confirm.

Or, if the timer is the only active function:



- ▶ Press the  touch button.

Or, to switch off the appliance:

- ▶ Press the  touch button 2x.

5.10 End of operation

When the set duration is up or, if the food probe is being used, when the set target temperature is reached:

- The selected operating mode ends automatically.
- An acoustic signal is emitted.
- Three options are displayed:
 - Select  to choose a new operating mode
 - Select : to extend the operation
 - Select  to switch the appliance off.
- The appliance switches off automatically after 3 minutes without interaction.



You can adjust the appliance end time individually (see page 49).

- As long as the temperature is above 80 °C, « Residual heat» appears in the display.
- If the food probe is plugged in, the food probe temperature is displayed. *



The food can be kept warm with residual heat for some time. As soon as the temperature falls below 80 °C, all the displays go out. If at this point the food probe is still plugged in, the displays only go out when the food probe is unplugged. *
The cooling fan can continue to run.

* Depending on the software version

For all operating modes that use steam, steam reduction can take place at the end of the cooking process. The steam is gradually released from the cooking space into the atmosphere – this takes about 1 minute. This means that there is no sudden rush of steam when the appliance door is opened; it can, however, be opened at any time.

Removing food from cooking space





Risk of scalding!

Hot steam or hot air may escape from the cooking space when the appliance door is opened.

The accessories get hot. Use protective gloves or oven cloths.

- ▶ Take the food out of the cooking space when done.
- ▶ Any condensate or food particles in the cooking space must be completely removed after each cooking session with steam.
- ▶ Wipe away traces of water or soiling with a soft cloth to prevent corrosion and unpleasant odours.
- ▶ Leave the appliance door open in the at-rest position until the cooking space has cooled down and dried out.

5.11 Switching the appliance off



- ▶ Press the  touch button.
 - An acoustic signal is emitted.
 - Any running operating mode or application is ended; if switched on, the timer, cooking space illumination or plate warmer will remain active.
 -  Residual heat» appears in the display.
 - If the food probe is plugged in, the food probe temperature is displayed. *

* Depending on the software version

- The following message appears in the display after all operating modes with steam: «Draining appliance. Please do not remove the water tank.»

- ▶ Press the  touch button again.
 - All touch buttons go out.
 - All functions are ended and switched off.

Or at the end of operation:

- ▶ Select the  option in the display.
 - An acoustic signal is emitted.
 - Any running operating mode or application is ended; if switched on, the timer, cooking space illumination or plate warmer will remain active.
 - The following appears in the display:  Residual heat».
 - If the food probe is plugged in, the food probe temperature is displayed. *

* Depending on the software version

- ▶ Press the  touch button.
 - All touch buttons go out.
 - All functions are ended and switched off.



The appliance is switched off if none of the touch buttons are illuminated any more and the display is dark.

The cooling fan can continue to run.

5.12 Emptying the water tank



Risk of scalding!

The water in the tank may be hot. If «Please do not remove the water tank» appears in the display, the temperature of the residual water is too high. Do not remove the water tank!

For safety reasons, the residual water is not pumped off until the temperature has fallen below a certain level.

When the appliance is switched off, the residual water is pumped back into the water tank.

The following appears in the display: «Water is being pumped off». When the water has been pumped back:

- ▶ Press the  touch button.
 - The water tank is ejected.
- ▶ Remove, empty and dry the water tank.
- ▶ Put the water tank back.



Any operating mode can be started again.

6 Microwave

6.1 Note on use



Refer to the «Safety precautions» section.

Porcelain, ceramic and earthenware cookware have cavities which can fill with water. Risk of cracking! Follow the manufacturers' instructions.



Suitable for microwave and combi mode



Not suitable for microwave and combi mode

Particularly suitable for microwave mode

- Glass, e.g. hardened glass dish
- Porcelain
- Microwaveable plastic, e.g. perforated plastic cooking tray
- Silicone baking moulds

Permitted for microwave mode

- Food probe with burls
- Aluminium packaging of convenience foods
- Wire shelf

Forbidden for microwave mode

- Cast iron pots
- Metal cookware
- Aluminium foil
- Baking trays
- Stainless steel trays

- Perforated stainless steel cooking tray
- Cookware with gold rim or metal decor
- Meat thermometer

6.2 Tips for microwave mode



Do not switch the microwave mode on until you have put the food in the cooking space.

- ▶ Cover food when just using the microwave mode to prevent it from drying out. Suitable covers include microwave food covers, glass or porcelain covers and microwaveable films.

The cooking space can become damp when using the microwave mode. To avoid unpleasant odours and corrosion in the cooking space, please observe the following:

- ▶ Cover liquid or steaming food – unless it should remain crispy.
- ▶ Wipe away traces of water and soiling with a soft cloth to prevent corrosion and unpleasant odours.
- ▶ To prevent damage to the appliance, leave the appliance door open in the at-rest position at the end of cooking until the cooking space has cooled down.

6.3 Microwave operation

- ▶ Select and start the operating mode (see page 24).

When the appliance door is opened, the microwave mode is immediately interrupted.

After the appliance door is closed, the operation continues.

The duration and the microwave power level can be checked and changed during operation (see page 24). To change PowerPlus, see Combi mode / PowerPlus (see page 22). To switch the microwave off, see Cancelling/ending the operating mode before time (see page 27).

- End of operation (see page 28).



When using the food probe, the microwave mode switches off when the set target temperature is reached.

Extending the operation

- ▶ Select the **→** option in the display within 3 minutes.

7 GourmetGuide

The GourmetGuide encompasses several programmes which make preparing meals as easy as possible for you. The following programmes can be called up:

Recipes	Vacuisine *
BakeOmatic	Defrosting
Professional baking	Wellness *
Soft roasting	Hygiene *
RegenerateOmatic	Keep warm *

* Depending on the software version





7.1 Recipe book

A recipe book contains recipes which are tailored to suit the particular appliance. These are already programmed into the appliance and run automatically once started.

A recipe book is included in the scope of delivery for the appliance and has already been unlocked in the appliance.

Provided that your appliance has the required operating modes, you can order additional recipe books (subject to charge) and then activate them in the appliance.



The following recipe books are available for your appliance:

-  Bi Baking treats
-  Si Magical steaming *
-  M Fast steaming
-  Q QueenSteam recipes * (available at www.vzug.com/queensteam)

* Depending on the software version

Unlocking a recipe book





When you buy a recipe book, you receive a password which is used to unlock the recipe book in the appliance. After it has been unlocked, the recipes are displayed in the appliance.

- ▶ If the appliance is switched off, first press the adjusting knob.
- ▶ Press the  touch button.
- ▶ Select .
- ▶ Select the recipe book that you wish to unlock.
 - The following appears in the display: «Do you want to unlock the recipe book?».
- ▶ Select «Yes».
- ▶ Enter the password using the on-screen keypad and confirm by selecting .
 - The recipe book is now unlocked.

Starting a recipe



For recipes that do not require preheating, place the food in the cold cooking space.

- ▶ If the appliance is switched off, first press the adjusting knob.
- ▶ Fill the water tank with fresh, cold drinking water and slot into position in the water tank compartment.
- ▶ Press the  touch button.
- ▶ Select .
- ▶ Select the desired recipe book or  «Own recipes».
- ▶ To select a recipe, choose .
- ▶ Select a recipe.
 - The recipe settings are displayed.
- ▶ If you wish, set the end time or delayed start.



When cooking recipes from recipe books, a delayed start is only possible if the cooking space does not need to be preheated and the food does not need to be stirred or turned partway through, for example.

- ▶ To start the recipe, select .
 - The recipe starts.
 - The display shows the current recipe step, the time remaining in this step and the entire duration of the recipe.

- The digital display shows the remaining time for the current recipe step.

In the course of the recipe

In the course of the recipe, it may be necessary to open the appliance door, e.g. to turn over the food or to spread a topping over it. In such an instance, operation is paused and the display shows instructions on what to do next.

To continue the recipe, proceed as follows:

- ▶ Open the appliance door.
- ▶ Carry out the action, e.g. turn over food.
- ▶ Close appliance door and select ✓ in the display.
 - The recipe will continue to run.



Cancelling the recipe

- ▶ In the recipe settings, select ■.
 - The following appears in the display: «Should the current recipe be cancelled?»
- ▶ To abort the recipe, select «Yes».
 - The recipe is cancelled.

7.2 Own recipes

Up to 24 of your own favourite recipes can be created and saved. A recipe can consist of several steps with any operating modes (including Professional baking), pauses and hold times, which run automatically once started. You can also change and save existing recipes.

Creating your own recipe



- ▶ If the appliance is switched off: first press the adjusting knob.
- ▶ Press the  touch button.
- ▶ Select .
- ▶ Select .
- ▶ To create a new recipe, select +.
 - The selection of operating modes including professional baking appears in the display.
- ▶ Select the desired operating mode.
- ▶ Set the target temperature, duration, temperature or temperature level for step 1.



If you are only making temperature settings, this step takes as long as is necessary for the cooking space to reach the required temperature.

- ▶ To confirm the settings, select ✓.
- ▶ To add a new step, select +.
- ▶ Set an operating mode, pause or hold time for step 2.



For the intermediate step  → «Hold», the heating continues to run and the cooking space temperature remains constant. For the intermediate step  «Pause», the cooking space is not heated any more and the temperature drops.

After a hold or pause step, a preheating stage can be set.

- ▶ To save the settings, select ✓.
 - The overview of the set steps is displayed.
- ▶ Set additional steps in the same way. A recipe can consist of up to 9 steps.
- ▶ To save the recipe, select .
 - The overview of the available storage spaces is displayed.

- ▶ Select the desired (empty) storage space and confirm.
- ▶ Enter the recipe name using the on-screen keypad and confirm by pressing ✓.
 - The recipe is now saved.
 - The following appears in the display: «Do you want to run the recipe?» If you do not wish to run the recipe, you will return to the recipes main menu.

Step duration

The duration of a step depends on whether values have been set for the target temperature, duration, temperature or temperature level. If multiple values have been set, e.g. the duration and the temperature, only one of these takes priority for the step duration.

The table below shows the priorities in descending order:

	Setting
1	Target temperature
2	Duration
3	Temperature / temperature level

Cancelling recipe entry/change

- ▶ Select ↶ in the overview of the set steps.
 - The following appears in the display: «Do you really want to cancel the recipe entry?»
- ▶ To cancel the recipe entry, select «Yes».
 - The menu for your own recipes or, if a recipe from a recipe book was changed, the menu for the recipe book is displayed.



Ending a step before time

This is only possible for  «Own recipes». If, for example when a recipe is running, you realize that the food or the cooking space is ready for the next step in the recipe even though the current step is still in progress, you can end the step before time.

- ▶ Select the symbol for target temperature, duration, temperature or temperature level in the operating mode settings. Pay attention to the priorities for the step duration as described under «Step duration».
- ▶ Set the displayed value to 0 or reduce it until it is less than the currently measured value.
- ▶ Press the adjusting knob to confirm.
 - The step is ended.
 - If it was the final step, the recipe ends too.
 - If it was not the final step, the next step starts.

Changing recipes

Any recipe – from a recipe book as well as your own recipes – can be copied and changed.

- ▶ Select the desired recipe book or .
- ▶ Select .
- ▶ Choose a recipe.
 - An overview of the steps in the recipe is displayed.

Changing a step

- ▶ Select the step to be changed.
- ▶ Make the settings and confirm with ✓.

Adding a step

- ▶ Select +.
- ▶ Make the settings and confirm with ✓.

Deleting a step

- ▶ Select .
 - An overview of the steps in the recipe is displayed.
- ▶ Select the step.
 - The following appears in the display: «Do you want to delete this step?»
- ▶ To delete the step, select «Yes».
 - The step is deleted.

Saving a changed recipe

- ▶ Select .
- ▶ Select storage space, enter the recipe name and confirm by pressing ✓.
 - The changed recipe is now saved.





A storage space that is already being used can be overwritten.

Recipes that have been amended from recipe books are not saved in the recipe book, but under  «Own recipes». The original recipe remains in the corresponding recipe book.

Deleting your own recipe

Any recipe in  «Own recipes» can be deleted.

- ▶ Select  «Own recipes».
- ▶ Select .
- ▶ Select the recipe to be deleted.
 - The following appears in the display: «Do you want to delete this recipe?»
- ▶ To delete the recipe, select «Yes».
 - The recipe is deleted.

7.3 Vacuisine *

* Depending on the software version

With  Vacuisine, meat, fish, vegetables and fruit can be prepared sous vide. The vacuum-packed food is gently steamed. The food probe temperature can be monitored with the food probe. The food probe temperature is the set cooking space temperature. This ensures that the food is cooked to the same degree of doneness throughout.



Temperature range	30–95 °C
Recommended value	60 °C
Level	1 to 4
Recommended maximum cooking time	48 hours

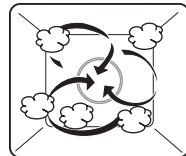

The cooking space is heated simultaneously by steam and hot air. The food is heated or cooked by steam.

Tips for an optimal result

- Only use fresh food. This applies to meat and fish in particular. Food that has already been kept for some time has a higher bacterial content and is therefore unsuitable for Vacuisine.
- Meat quality: Both lean (e.g. fillet) and marbled, more sinewy (e.g. stewing meat and belly pork) cuts of meat and can be prepared optimally using Vacuisine.

Preparing the food

- Vacuum seal the food. For this, see the tips in the operating instructions for the vacuum drawer, on the homepage or in the recipe brochure.
 - To monitor the food probe temperature of the meat with the food probe, the spot where the food probe punctures the vacuum bag must be sealed with a sealing pad (see page 62). This ensures that the vacuum is maintained in the bag.
- ▶ Attach a sealing pad to the bag containing the vacuumed food, having first ensured that the bag is clean and dry.
 - ▶ Insert the food probe through the sealing pad and the bag, and into the meat. The tip of the food probe should be inserted into the centre of the thickest end of the meat.

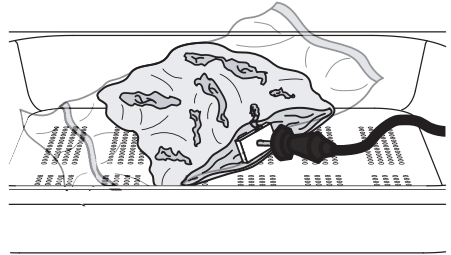

Selecting and starting Vacuisine

- ▶ Put the perforated cooking tray into the cooking space and place the vacuum-sealed food in it.





Ensure that the bags are adjacent and not overlapping so that the steam can circulate and cook the food evenly.



The filled water tank must be in position in the water tank compartment.



If the desired cooking time is longer than 10 hours, place the stainless steel tray underneath the perforated cooking tray.

- ▶ Plug the food probe into the appliance, if necessary.
- ▶ If the appliance is switched off: first press the adjusting knob.
- ▶ Press the  touch button.
- ▶ Select .
- ▶ Make the desired settings.
- ▶ If a cooking time of 10–48 hours is required, use the timer (see page 27) only to check the cooking time. «Vacuisine» will continue to run until interrupted manually. The cooking time can be monitored with the timer.
- ▶ To start Vacuisine, select ▶.



With «Vacuisine», the food probe only serves to monitor the food probe temperature. It is not possible to set the food probe temperature. If the food probe is plugged in for monitoring, an acoustic signal is emitted when the core temperature of the meat is roughly the same as the temperature of the cooking space.

Monitoring the food probe temperature using the food probe temperature

- ▶ When the food probe temperature and the cooking space temperature are roughly the same:
 - an acoustic signal is emitted.
 - «Food has reached food probe temperature.» appears in the display.
 - the meat is cooked. The operation is not cancelled.
 - the meat can be left in the appliance for up to an hour.
- ▶ If the cooking time (not timer!) is accidentally set too short and is up before the food probe temperature has been reached:
 - the operation is not cancelled.
 - an acoustic signal is emitted.
 - «Food has not yet reached food probe temperature. Operation will continue.» appears in the display.



7.4 BakeOmatic

••• **A** BakeOmatic comprises applications for different food groups. The size and shape of the food are recognized and the duration and cooking space climate are adjusted automatically. **A** BakeOmatic is suitable for the following foods and dishes:

- | | |
|--|---|
|  Fresh aperitif nibbles |  * Frozen pizza (F) * |
|  * Frozen aperitif nibbles (F) * |  Flan |
|  Gratin |  Bread |
|  Soufflé |  Plaited bread |
|  Baked potatoes |  Yeast pastries with filling |
|  * Pre-fried frozen products (F) * |  Loaf cake |
|  Braising meat |  Muffins / tray-baked cake |
|  Fresh pizza | |

* Depending on the software version

Degree of browning

For certain food categories, the degree of browning can be adjusted by selecting the  «lightly browned»,  «medium browned» or  «well browned» setting.



When used for frozen products, the approximate duration indicated on the packaging must be selected instead of the degree of browning. Frozen products are prepared in a variety of ways.

Duration

When BakeOmatic starts, sensors determine the optimum duration. The effective duration is displayed after about 10–15 minutes.



Before starting, the cooking space must have cooled down and be dry in order to determine the optimum duration.

The appliance door must not be opened whilst the duration is being determined.

Preheating

In the case of the  «Flan» food group, after starting, separate preheating takes place first. Put the food in after preheating has ended.



Selecting and starting BakeOmatic



The filled water tank must be in position in the water tank compartment.



A delayed start is only possible for applications where preheating is not required and is only suitable for food that does not need to be refrigerated or to rise.

- ▶ If the appliance is switched off: first press the adjusting knob.
- ▶ Press the  touch button.
- ▶ Select **A**.
- ▶ Select the desired application.
- ▶ Select the degree of browning or, for frozen products, the appropriate time indicated on the packaging.
 - The BakeOmatic settings are displayed.
- ▶ Set an end time or delayed start, if required.
- ▶ To start BakeOmatic, select **▶**.
 - Depending on the application, the cooking space may be preheated first.
 - An acoustic signal is emitted and in the display appears: «Introduce food. Select ✓ to continue.».
- ▶ Put the food at the appropriate level.
- ▶ To confirm the message, select **✓**.
 - The following appears in the display: « is being determined.».
 - The countdown to the time remaining appears in the display and in the digital display.



The appliance door must not be opened whilst the duration is being determined. Otherwise, the optimal duration and temperature will not be calculated correctly.

7.5 Professional baking

With  professional baking, the cold cooking space is heated by a steam phase (about 10 minutes) and a hot air phase, which follows automatically. This makes yeast and puff pastries light and airy while also forming a nice, shiny crust. «Proofing» allows you to proof a large batch of dough or pre-prepared portions at optimal temperature and humidity levels.

 Professional baking has the following range of uses:



Bread



Plaited bread



Puff pastry



Proofing





The appliance door must not be opened during the steam phase, as this would allow cold air to stream in, extending the steam phase and oversteaming the bread. The bread would come out flatter as a result.

Tips

- Allow bread, bread buns and other yeast pastries to proof for about 15 minutes after forming into shape. Place on a stainless steel tray, which has been lined with baking paper, put it into the cold cooking space and bake.
- The adjustable temperature corresponds to that of the hot air phase. The temperature during the steam phase is preset.
- For a nice, crispy crust: the smaller the item to be baked, the higher the temperature. The optimum temperature for bread buns is generally higher than for a single loaf of bread.
- When using  «Plaited bread», we recommend brushing the shaped dough with egg wash.

Selecting and starting professional baking

- ▶ Put in the food.
- ▶ If the appliance is switched off, first press the adjusting knob.
- ▶ Press the  touch button.
- ▶ Select .
- ▶ Select the desired application.
 - The operating mode settings are displayed.
- ▶ Set the temperature, duration and, if necessary, an end time or delayed start and confirm.
- ▶ To start  professional baking, select ▶.





The filled water tank must be in position in the water tank compartment.

7.6 Soft roasting

How it functions

The  soft roasting function allows high-quality cuts of meat to be prepared gently. You can select exactly when the cooking process is complete, irrespective of the weight and thickness of the meat. The temperature is automatically regulated.

The cooking time can be set to between 2½ and 4½ hours for  «Soft roasting seared» or between 1½ and 2½ hours for  «Soft roasting with steam».

Tips for an optimal result

- Take the meat out of the refrigerator some 30–60 minutes before soft roasting.
- Weight of meat:
 - Soft roasting seared: 500–2000 g
 - Soft roasting with steam: 500–1500 g
- Meat food probe temperature: up to 90 °C
- Meat thickness: at least 4 cm
- Quality: lean, high-quality meat

Soft roasting table for «Soft roasting with steam» and «Soft roasting seared»

Cut of meat	Degree of doneness	Recommended target temperature °C	
		With steam	Seared
Fillet of veal	rare	54	58
	medium	58	62
Rump or loin of veal	medium	59	63
Fillet of beef	rare	49	53
	medium	53	57
Rib-eye or sirloin	rare	49	53
	medium	53	57
Rump of beef	medium	59	63
Rump or loin of pork	medium	61	65
Leg of lamb	rare	59	63
	medium	63	67
Freely select meat type	–	60	70

«Soft roasting seared»

- ▶ Season or marinate the meat.



Remove any marinade made with herbs, mustard, etc. from the meat before searing. These ingredients burn easily.

- ▶ Salt the meat immediately before searing.
- ▶ Briefly sear the meat all over for no longer than 5 minutes.
- ▶ Then place the meat in a glass or porcelain roasting dish.



If you do not intend to sear the meat until after the soft roasting, lower the recommended target temperature by around 3–4 °C.

- ▶ Insert the food probe into the meat so that the tip is in the centre of the thickest part.



The food probe must be inserted as far into the middle of the meat as possible to get a correct reading of the food probe temperature. The temperature inside the meat is crucial for optimal results at the end of cooking.

- ▶ Put the wire shelf at level 2 and place the dish on it.
- ▶ Insert the food probe plug into the socket.
- ▶ Start \mathcal{L}^{\ominus} «Soft roasting seared» (see page 41).

«Soft roasting with steam»

For \mathcal{L}^{\oplus} «Soft roasting with steam», the meat is cooked gently with steam. Since steam transfers energy better, shorter cooking times and thus energy savings are possible. As steam produces condensate, more residual water is left in the cooking space at the end of the cooking process than with «Soft roasting seared».

- ▶ Insert the food probe into the meat so that the tip is in the centre of the thickest part.



The food probe must be inserted as far into the middle of the meat as possible to get a correct reading of the food probe temperature. The temperature inside the meat is crucial for optimal results at the end of cooking.

- ▶ Put the stainless steel tray at level 2 and place the meat on the perforated plastic cooking tray on top.



Tip: If you would like to add more flavour to the meat, lay it on a bed of fresh herbs or hay.

- ▶ Insert the food probe plug into the socket.
- ▶ Start  «Soft roasting with steam» (see page 41).
- ▶ After soft roasting, gently sear the meat all over for a total of 4–6 minutes.
- ▶ After searing, wrap the whole piece of meat in aluminium foil and leave it covered for about 5 minutes.
- ▶ Cut the meat and serve immediately.





As the meat is only seared after soft roasting for optical reasons, the recommended target temperature is 4 °C lower than for «Soft roasting seared».

Selecting and starting soft roasting





The longer the meat is cooked, the more tender and succulent it becomes. This applies particularly for thicker pieces of meat.

The target temperature cannot be changed once soft roasting has started.

- ▶ If the appliance is switched off, first press the adjusting knob.
- ▶ Press the  touch button.
- ▶ Select .
- ▶ Select the desired soft roasting method.
- ▶ Select the desired type of meat.
- ▶ Select the desired cut.



▶ If the desired type of meat or cut cannot be selected, select the  «Freely select meat type» option.

- ▶ Select the degree of doneness (not possible for  «Freely select meat type»).
- The operating mode settings are displayed.
- A recommended value appears above the target temperature.
- ▶ Adjust the recommended value if necessary and set a delayed start if you wish.
- ▶ To start soft roasting, select .





The food probe must be plugged in.

- Soft roasting starts.
- The set target temperature, the current food probe temperature and the remaining time are displayed.
- The remaining time appears in the digital display.







The appliance door must be closed during operation. If the appliance door is opened while soft roasting is running, the operation is interrupted and then, after a short time, cancelled.

Inadvertently interrupting the programme

- ▶ If the  touch button is pressed, the soft roasting programme is interrupted.
- The following appears in the display: «Should  be cancelled?»
- ▶ To continue soft roasting, select «No».
- Operation is continued.

Cancelling / ending soft roasting before time

- ▶ Select  in the soft roasting settings or press the  touch button.
 - The following appears in the display: «Should  be cancelled?».
- ▶ Select «Yes».
 - Operation is cancelled.
- ▶ To switch off the appliance, press the  touch button.





If you accidentally pressed «Yes» or you wish to finish cooking the meat, you must press the  touch button and select an operating mode. «Soft roasting» is not suitable for already cooked meat.



7.7 RegenerateOmatic

How it functions

With  «RegenerateOmatic», food can be heated without having to set an operating mode, temperature or duration. The quantity and shape of the food are recognized and the regeneration time and cooking space climate are adjusted individually and automatically.

Degree of moisture



With RegenerateOmatic, you can choose between  «Regenerate moist» and  «Regenerate crispy».

Degree of moisture	Uses
	Foods that should not dry out e.g. vegetables, meat, pasta
	Foods that should be crispy after regeneration e.g. pizza, flans, aperitif nibbles

Regeneration time

Sensors detect when the food is hot.

The approximate time for the most common uses is as follows:

-  «Regenerate moist»: 10–14 minutes
-  «Regenerate crispy»: 14–18 minutes





Selecting and starting RegenerateOmatic

Before starting, the cooking space should have cooled down and be dry in order to determine the optimum duration.

The appliance door should not be opened during operation.



The filled water tank must be in position in the water tank compartment.

- ▶ Put the food in a heat-resistant dish, place it on the wire shelf and push it into the cold cooking space.
- ▶ If the appliance is switched off: first press the adjusting knob.
- ▶ Press the  touch button.
- ▶ Select .
- ▶ Select the  «Moist» or  «Crispy» degree of regeneration.
- ▶ Set an end time or delayed start, if required.



An estimated average regeneration time is used to calculate the delayed start. The regeneration can therefore also be ended earlier or later.

- ▶ Select ► to start.
 - Operation starts.
 - The following appears in the display: «→ is being determined.».
 - The countdown to the time remaining then appears in the display.



The operation cannot be extended when regeneration finishes.



7.8 Defrosting

Different types of food can be defrosted using  «Defrost». After the desired quantity has been entered, the duration and cooking space climate are adjusted automatically.

Selecting and starting defrosting



No delayed start can be set.

- ▶ If the appliance is switched off: first press the adjusting knob.
- ▶ Press the  touch button.
- ▶ Select .
 - The selection of foods appears in the display.
- ▶ Select the type of food.
- ▶ Set the desired weight or quantity.
 - The operating mode settings are displayed.
- ▶ Select ► to start.

7.9 Wellness *

* Depending on the software version

With  «Wellness», the following items can be prepared for personal well-being:

- Hot towels
- Hot wraps
- Hot massage stones
- Cherry stone or grape seed cushions



Caution hot!

Feel the temperature of the heated objects with your hand first before placing them on any other parts of the body.

Hot towels

Before starting the application:

- ▶ Wet and wring out the towels.
- ▶ Open the towels and place in the perforated cooking tray or:
- ▶ Roll up the towels to the desired size and place in the perforated cooking tray.

Hot wraps

Before starting the application:

- ▶ Spread the prepared towels out across the perforated cooking tray.

Hot massage stones

Before starting the application:

- ▶ Put the clean, smooth massage stones in a suitable container and place it directly on the floor of the cooking space.

Cherry stone or grape seed cushions

Before starting the application:

- ▶ Put the cherry stone or grape seed cushions in a suitable container and place it directly on the floor of the cooking space.

7.10 Hygiene *

* Depending on the software version

 «Hygiene» can be used for sterilizing containers. The following applications are available:

- «Sterilize baby bottles» replaces the need to boil baby bottles in hot water.
- «Prepare jam jars» replaces the need to prepare empty jam jars by rinsing them with hot water.
- «Preserve jam» helps to preserve the jam for longer.

Feeding bottles

Before starting the application:

- ▶ Clean the bottles.
- ▶ Unscrew the feeding bottles and place all parts into the perforated cooking tray.

After the application has finished:

- ▶ Stand the bottles upside down on a clean kitchen towel and leave to dry completely.

7.11 Keep warm *

* Depending on the software version

Cooked foods can be kept warm using the  «Keep warm» setting.

 If the cooking space is already hot, open the appliance door and allow the cooking space to cool down for 3 to 4 minutes before starting the «Keep warm» function. This ensures that the food does not overcook.

The longer the food is kept warm, the greater the changes may be to the consistency of the food.

8 EasyCook



















 EasyCook helps you to prepare any food simply and conveniently. After choosing the food group and food, the appliance suggests the suitable operating modes or Gourmet-Guide applications, including the settings and accessories.

 The brochure of the same name, which you received with the operating instructions, contains the same settings information in paper form. The values given for temperature or temperature levels and duration serve only as guide. They may vary depending on the type and size of the food as well as on individual preference.

8.1 Overview of food groups

Foods are categorized into different groups; an item of food can appear in more than one group.

The following food groups can be selected:

 Vegetables	 Flans and pizza
 Fruit	 Bakery products
 Herbs	 Baked dishes and gratin
 Mushrooms	 Accompaniments
 Pulses	 Desserts
 Grains	 Dairy products
 Potatoes	 Eggs
 Meat	 Chestnuts
 Poultry	 Liquids and liquid foods
 Fish and seafood	

8.2 Selecting and starting foods





A delayed start is only possible for applications where preheating is not required and is only suitable for food that does not need to be refrigerated or to rise.

- ▶ If the appliance is switched off: first press the adjusting knob.
- ▶ Press the  touch button.
 - The overview of food groups is displayed.
- ▶ Select the food group.
- ▶ Choose the desired type of food.
- ▶ If necessary: select the shape (whole, pieces, etc).
- ▶ If necessary: select the preparation method (cooking, baking, etc.).



PowerCook also uses microwaves in the cooking process.

- The display contains information about:
 - Temperature
 - Duration
 - Preheating necessary / not necessary
 - Accessories needed
 - Level
 - Possible tips
- ▶ Select .
- ▶ The operating mode summary is displayed.
- ▶ To start operation, select .



You can change the set values to a limited extent.



9 Favourites

Up to 24 operating modes, GourmetGuide and EasyCook applications together with the settings made can be saved as favourites.

9.1 Creating favourites

- ▶ Select an operating mode, GourmetGuide or EasyCook application.
- ▶ Make the settings.
- ▶ Press the  touch button.
 - The favourites menu opens.
- ▶ Select a storage space and confirm.
- ▶ Enter the name of the favourite using the on-screen keypad and confirm.
 - The favourite is saved.



9.2 Selecting and starting favourites

- ▶ Press the  touch button.
- ▶ Choose the desired favourite and select «Yes».
- ▶ To start the favourite, select .
 - The favourite starts.

9.3 Changing favourites

- ▶ Select the desired favourites.
- ▶ Adjust the settings as required.
- ▶ Press the  touch button.
- ▶ Select the storage space or favourite that is to be overwritten.
- ▶ Enter the favourite name or overwrite as appropriate.
 - The changed favourite is saved.

9.4 Deleting favourites





- ▶ If the appliance has another menu open, press the  touch button.
- ▶ Select .
- ▶ Select the favourite to be deleted.
 - The following appears in the display: «Do you want to delete this favourite?».
- ▶ To delete the favourite, select «Yes».
 - The favourite is deleted.

10 Tips and tricks

10.1 Unsatisfactory cooking result...

... when baking and roasting



Result	Solution
<ul style="list-style-type: none"> ▪ The baking or roast looks good on the outside but is still doughy or raw on the inside. 	<ul style="list-style-type: none"> ▶ Next time, set a lower temperature and lengthen the operating time.
<ul style="list-style-type: none"> ▪ The cake collapses. 	<ul style="list-style-type: none"> ▶ Check that the settings used correspond to those recommended in «EasyCook». ▶ Next time, set a lower temperature and lengthen the operating time. ▶ Stir the cake mixture well. When finished, bake immediately. ▶ For whisked sponges, beat the egg yolks / egg whites to a foam a little longer and then carefully fold into the mixture. When finished, bake immediately. ▶ Follow the instructions on how much baking powder to add.

Result	Solution
<ul style="list-style-type: none"> ▪ The baking has browned unevenly. 	<ul style="list-style-type: none"> ▶ Next time, set a lower temperature and adjust the operating time. ▶ If using , ,  and , check that the levels used correspond to those recommended in «EasyCook». ▶ Do not push baking tins or bulky foodstuff right to the back of the cooking space.
<ul style="list-style-type: none"> ▪ The baked goods have come out lighter on one baking tray than on the other. 	<ul style="list-style-type: none"> ▶ Check that the settings used correspond to those recommended in «EasyCook».



Some uneven browning is normal. More even browning is generally achieved at lower temperatures.





... for regenerated foods

Result	Solution
<ul style="list-style-type: none"> ▪ Regenerated food is dried out. 	<ul style="list-style-type: none"> ▶ Next time, set a lower temperature and reduce the operating time. ▶ Use  «RegenerateOmatic moist».
<ul style="list-style-type: none"> ▪ Too much condensate on or around the regenerated food. 	<ul style="list-style-type: none"> ▶ Next time, set a higher temperature and lengthen the operating time. ▶ Use  «RegenerateOmatic crispy».

10.2 General tips

- Several foods can be cooked simultaneously to save energy, e.g. rice or pulses together with vegetables with similar cooking times.
- With the appropriate amount of liquid, grains, e.g. rice or millet, and pulses, e.g. lentils, cook directly in suitable tableware.
- Put the tableware directly in the hardened glass dish or on the wire shelf.

10.3 Saving energy

The  and  operating modes consume less energy than the  and  operating modes.

- ▶ Avoid opening the appliance door frequently.
- ▶ Only switch the illumination on when needed.
- ▶ For gratins, use the residual heat: for cooking times over 30 minutes, switch the appliance off 5–10 minutes before the end of the operating time.
- ▶ Minimize preheating.
- ▶ Only preheat the cooking space if the cooking or baking results depend on it.



Power consumption can be reduced to a minimum by selecting «Hide time» in the user settings. Despite EcoStandby, all safety functions remain active.

11 User settings

11.1 Overview of user settings

	Language		Assistance functions
	Display		Temperature
	Date		Childproof lock
	Clock		Appliance information
	Notifications		Demo mode
	Descalce appliance		Check connection
	Water hardness		Factory settings
	Loudness		

11.2 Adjusting user settings

- ▶ If the appliance is switched off, first press the adjusting knob.
- ▶ Press the  touch button.

- The user settings main menu appears in the display:

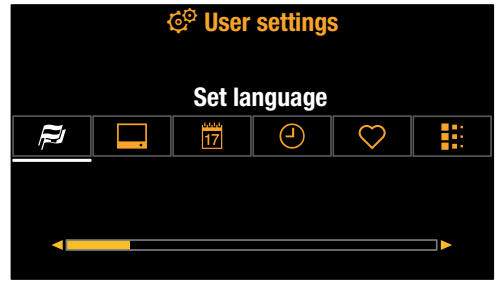

- ▶ Select the desired user setting or submenu.
- ▶ Adjust the desired user setting and press the adjusting knob to confirm.
 - Either the user settings main menu or the relevant submenu appears in the display.
- ▶ To exit a submenu and return to the user settings main menu, select ↶.
- ▶ To exit the user settings, press a different touch button or the ⏻ touch button.



All user settings are retained in the event of a power failure.

11.3 Language

The language in the display can be changed. Different languages are available for selection.

11.4 Display

Brightness

The brightness of the display can be changed.

Background images

You can turn the background image display on and off. If background images are activated, different images are displayed depending on the menu.

Start screen *

* Depending on the software version

With this user setting, you can determine the menu that is displayed when you start the appliance. The following menus can be selected:

- Operating modes (factory setting)
- GourmetGuide
- EasyCook
- Favourites

Appliance switch-off time

If no operating mode is running but the appliance is switched on, it is automatically switched off after a certain period of time without any user interaction. Example: After the end of an operating mode.



The appliance switch-off time can be set between 3 and 30 minutes; the factory setting is 15 minutes.

11.5 Date

The date can be called up and changed.

11.6 Clock

The following time functions are available:

-  Time
- ¹²/₂₄ Time format
-  Time display
-  Mains synchronization

Time format

The time can be displayed in the European 24-hour time format or the US 12-hour format (a.m./p.m.).

Time display

With the «Show time» setting (factory setting), the time is dimmed between 00:00 and 06:00 (24-hour format) or 12:00 a.m. and 06:00 a.m. (12-hour format).

If «Hide time» is selected, the displays are not illuminated when the appliance is off.



To reduce power consumption to a minimum, select «Hide time» in the user settings. Despite EcoStandby, all safety functions remain active.

Mains synchronization

Mains synchronization synchronizes the appliance clock with the mains frequency. Irregular mains frequency can cause the clock to not run correctly. A pulse generator inside the appliance is used when mains synchronization is switched off.

11.7 Notifications

Acoustic signals and instruction messages can be switched off or disabled. Essential acoustic signals (such as the timer, end of operation and switch appliance off) cannot be switched off or disabled.

11.8 Descaling the appliance

This function can be used to descale the appliance or read the remaining operating time until the next descaling process.

See Descaling (see page 54).

11.9 Water hardness

The appliance features a system that automatically indicates when it is time to descale. The system can be optimized for households with soft water (also through using a water softening appliance) and medium water hardness by changing the user settings to the relevant range of water hardness.

There are three settings for water hardness:

Type	Water hardness [°fH]	Water hardness [°dH]	Water hardness [°eH]
▪ Hard	36 to 50	21 to 28	26 to 35
▪ Medium	16 to 35	9 to 20	12 to 25
▪ Soft	1 to 15	1 to 8	1 to 11

11.10 Loudness

The acoustic signal can be set at one of two levels of loudness or can be completely switched off.



An acoustic signal is emitted in the event of a malfunction even if the setting is set to «off».

A short acoustic signal is emitted when the appliance is switched off even if the setting is set to «off» (safety function).

11.11 Assistance functions

Illumination

The «Automatic» setting switches on the cooking space illumination:

- 3 minutes before a cooking process ends, e.g. in the case of an automatic programme or an operating mode with a set duration,
- if the operation is ended before time, i.e. cancelled (using ■ or the ⏻ touch button),
- when the appliance door is opened.



Press the  touch button to switch the illumination on or off at any time.

If the illumination is not switched off, it will go off automatically within 5 minutes to save energy.

Fast heating

With the «Automatic» setting, fast heating is switched on automatically wherever possible.

Water tank

With the «Automatic» setting, the water tank is automatically ejected when it is empty.

Press and go

 «Press and go» refers to the period of time after which an operating mode/programme starts automatically as long as all necessary settings are available or have been made. Adjusting the settings restarts the countdown.

 «Press and go» can be switched on or off.

When  «Press and go» is activated, values between 10 seconds and 1 minute are possible; the factory setting is 20 seconds.

11.12 Temperature

Temperature unit

The temperature can be displayed in «°C» or «°F».

- °C: Degrees Celsius
- °F: Degrees Fahrenheit

Default value for soft roasting

The default value is the target temperature that is automatically set when soft roasting. With this user setting, it can be increased or decreased by up to 4 °C; the setting then applies for all cuts of meat.

Example: When using «Soft roasting seared» with a 2 °C increase in the default value, a «medium» fillet of beef is cooked to a target temperature of 59 °C instead of 57 °C.

11.13 Childproof lock

The childproof lock is to prevent children accidentally switching on the appliance. When the childproof lock is activated, the appliance can only be operated after first entering a code. The code is displayed in reverse order when unlocking.



The childproof lock activates 3 minutes after the appliance is switched off.

11.14 Appliance information

Under  «Appliance information», you will find:

- The article number and serial number (FN) of your appliance
- The software versions of your appliance as well as the acoustic signals and background images currently being used (depending on model)
- The operating data:
 - number of descaling processes already performed
 - date and time of the last descaling process
 - steam operating time to date

11.15 Demo mode

In demo mode, almost all the appliance functions are available but it is not possible to cook with the appliance. This ensures operating safety during product demonstrations and consultations.

It is only possible to switch demo mode on and off with a safety code.

11.16 Checking the connection *

* Depending on the software version

This function is used by testing institutes to check whether the appliance has the connected load required.

11.17 Factory settings

If one or more user settings have been changed, these can be reset to the factory settings.

12 Care and maintenance



Risk of burns from hot surfaces!

You should allow the appliance and the accessories to cool before cleaning.

Do not reach into the water tank compartment if the following appears in the display: «Please do not remove the water tank».

Improper use can result in damage to the appliance!

Do not use any abrasive or caustic cleaning agents, metal scrapers that are sharp or scratch, steel wool, abrasive scouring pads, etc. These products will damage the surfaces. Glass surfaces that are scratched can crack.

Never use a steam cleaner to clean the appliance.



Risk of leaking microwaves!

Regularly check the appliance door, the door seal and the door lock. If these parts are damaged, do not use the appliance in the microwave mode any more.

12.1 Cleaning the exterior

- ▶ Remove any soiling or excess cleaning solution immediately.
- ▶ Clean the surfaces with a soft cloth dampened with water and a little washing-up liquid – for metallic surfaces rub in the direction of the original polish lines.
- ▶ Wipe dry with a soft cloth.

12.2 Cleaning the cooking space

 **Incorrect handling can result in damage to the appliance!**
Do not bend the temperature sensor.

 **Clean the microwave inlet in the top of the cooking space using a soft cloth dampened with water. Do not use cleaning agents.**

Do not clean the microwave inlet using a sharp or pointed object as it is sensitive to shocks.

- ▶ Clean the cooking space regularly, especially if food has been spilt. Take care that no grease splashes or food residues harden.
- ▶ Any condensate or food particles must be completely removed after each cooking session with steam.
- ▶ Place the glass dish or stainless steel tray under the perforated cooking tray or wire shelf when cooking to catch food particles and condensate.
- ▶ Remove any soiling from the cooking space while still hand warm. Use a soft cloth dampened with water and a little washing-up liquid. Wipe dry with a soft cloth.
- ▶ To remove dried-on soiling more easily, switch the appliance on for about 30 minutes beforehand, setting it to the  operating mode and a temperature of 80 °C. This will soften the soiling.
- ▶ For stubborn soiling, clean the cooking space when cold with a grease-dissolving spray cleaner or cream cleaner in accordance with the manufacturer's instructions.

12.3 Cleaning the appliance door

 **Under no circumstances may the appliance door be removed, otherwise the protection against leaking microwaves is no longer guaranteed.**

Do not use abrasive cleaning agents or cleaning aids such as steel wool, knives, glass scrapers, razor blades, etc. to clean the door glass. Scratches on the door glass could cause a breakage.

- ▶ Clean the appliance door with a soft cloth dampened with water and a little washing-up liquid.
- ▶ Wipe dry with a soft cloth.

 **Remove cleaning products from the door seal and trim kit immediately.**

Risk of damage to plastic. Protection from leaking microwaves is not guaranteed if the seals are damaged.

12.4 Cleaning the door seal

- ▶ Clean the door seal with a soft cloth dampened with water, but do not use any cleaning agent.
- ▶ Wipe dry with a soft cloth.

12.5 Replacing the door seal

For safety reasons, the door seal must be replaced by our Customer Services.

12.6 Replacing the halogen light bulb

For safety reasons, the halogen light bulb must be replaced by our Customer Services.

12.7 Cleaning the accessories and shelf guides



Incorrect handling can cause damage!

Do not clean the food probe or water tank in the dishwasher.

- The glass dish, the stainless steel tray, the perforated cooking tray, the wire shelf and the shelf guides can be cleaned in the dishwasher.
- The baking tray can be cleaned in the dishwasher; however, this will affect its non-stick properties.
- Watermarks in the water tank can be removed using a standard descaler (do not use washing-up liquid!).
- ▶ Clean the food probe with a soft cloth dampened with water and a little washing-up liquid.
- ▶ If the water tank valve drips, descale it.

Removing the shelf guides

- ▶ Unscrew the knurled nuts **1** in the front of the shelf guides in an anti-clockwise direction.
- ▶ Pull the shelf guides **2** to the side of the screws and remove from the front.

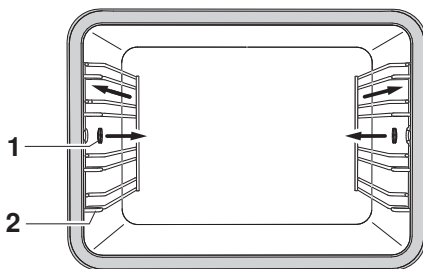

Reassembling the shelf guides

- ▶ Insert the shelf guides into the openings in the back wall of the cooking space and position on the screws. Place the knurled nuts on the screws and tighten securely in a clockwise direction.

12.8 Descaling

How it functions

Whenever steam is produced, depending on the hardness of the local water supply (i.e. the limescale content of the water), limescale is deposited in the boiler.

The appliance automatically detects and indicates when descaling is necessary.

– After pressing the  touch button and finishing a cooking process, the following appears in the display:

Would you like to descale the appliance now?
You must accompany the process.



We recommend descaling the appliance whenever the warning appears in the display. Continued to descale the appliance will likely impair its functions or cause damage to the appliance. Descaling takes about 45 minutes.

Descaling interval

The time interval between descaling depends on the hardness of the water and frequency of use. If steaming 4× 30 minutes per week, the appliance must be descaled – depending on water hardness – roughly as follows:

Water hardness	Descalce after about
Hard	5 months
Medium	8 months
Soft	12 months

Read remaining operating time

The remaining steam operating time until the next descaling process can be read in the user settings under «Descaling».

Descaler

durgol swiss steamer



Using the wrong descaler can damage the appliance!

Only use «durgol swiss steamer» to descale your appliance. The descaler contains highly effective acid. Immediately rinse away any splashes with water. Follow the manufacturer's instructions.



See «Accessories and spare parts» for where to obtain this descaler (see page 61).



«durgol swiss steamer» was developed especially for this appliance.

Standard descaling solutions are not suitable as they may contain foam-creating additives or not be effective enough.

Using a different descaler could cause

- overfoaming inside the appliance
- insufficient descaling of the boiler
- damage to the appliance in the worst case.

Starting the descaling process



The appliance must have cooled down before descaling.

Remove accessories, cookware or other objects from the cooking space. Do not leave the appliance unattended: during the descaling process, the descaler must be filled and the water tank must be emptied. The appliance door must be kept closed during descaling.

When the following message appears in the display «Would you like to descale the appliance now? You must accompany the process.»:

- ▶ Select «Yes».
- ▶ The following appears in the display: «The appliance is being prepared for descaling.»



If an acoustic signal is emitted and « Residual heat too high» appears in the display, the appliance has not cooled down sufficiently and the descaling process cannot be started.

- ▶ Allow the appliance to cool down.
- ▶ As soon as the corresponding message appears in the display: fill the water tank with 0.5 l undiluted descaler, insert the tank and select ▶.
 - The descaling process starts.
 - The following appears in the display: «Descaling appliance.»



For safety reasons, once started the descaling process cannot be cancelled.

Replacing the rinsing solution

- ▶ As soon as the corresponding message appears in the display, remove the water tank, pour the rinsing solution away and fill it with 1 l warm water.
- ▶ Put the water tank back.
 - The rinsing phase starts automatically.
 - The following appears in the display: «Rinsing appliance.».
- ▶ Repeat the process as often as is necessary.







As the water is heated up during final rinsing, the appliance door may steam up.

Ending the descaling process

- ▶ As soon as the corresponding message appears in the display, remove, empty and dry the water tank.
- ▶ Wipe up any water in the bottom of the cooking space with a soft cloth.
- ▶ To confirm the message, select ✓.
 - The following appears in the display: «Appliance has been successfully descaled».
- ▶ To confirm the message, select ✓.
 - The appliance is ready for operation again.



For the , ,  or  operating modes, after descaling, the water that is pumped back into the water tank may not be clear. This will not affect the cooking or baking characteristics nor the quality of the food being cooked or baked.

13 Trouble-shooting

13.1 What to do if ...

This section lists faults that can be solved simply by following the instructions given. If another fault is displayed or the fault cannot be remedied, please call Customer Services.



Before calling Customer Services, please note down the error message in full.

Fxx/Exxx see operating instructions

FNxxxxx xxxxxx.

... the appliance is not working

Possible cause	Solution
▪ A household fuse or circuit breaker has tripped.	▶ Change the fuse. ▶ Reset the circuit breaker.
▪ The fuse or circuit breaker keeps blowing.	▶ Call Customer Services.
▪ An interruption in the mains power supply.	▶ Check the power supply.
▪ Demo mode is switched on.	It is only possible to switch off demo mode with a safety code. ▶ Call Customer Services.
▪ The appliance is faulty.	▶ Call Customer Services.

... just the illumination is not working

Possible cause	Solution
▪ The halogen light is defective.	▶ Call Customer Services.

... the cooking time seems unusually long

Possible cause	Solution
▪ The appliance only has a single-phase connection.	▶ Establish a two-phase connection.

... when grilling, thick smoke is given off

Possible cause	Solution
▪ The food is too near to the heating elements.	▶ Check that the level selected corresponds to the «EasyCook».
▪ Grill setting is too high.	▶ Reduce the grill setting.

... no visible steam is produced when steaming

Possible cause	Solution
▪ The temperature of the cooking space is over 100 °C.	No solution required: Steam is invisible above 100 °C.

... hot air flows out of the appliance during microwave operation

Possible cause	Solution
<ul style="list-style-type: none"> ▪ Normal functional state. The heat emitted by the food warms the air in the cooking space. This is then discharged to the outside. The heated air contains no microwaves. 	<ul style="list-style-type: none"> ▶ Ventilation slots must be kept unobstructed.

... the food probe temperature is not displayed

Possible cause	Solution
<ul style="list-style-type: none"> ▪ The food probe is not plugged in correctly. 	<ul style="list-style-type: none"> ▶ Check whether the food probe is correctly plugged into the socket. ▶ Check whether the food probe is correctly inserted in the food: The tip must be in the centre of the thickest part.
<ul style="list-style-type: none"> ▪ In the selected automatic programme, the food probe cannot be used; the $\Lambda^{\circ}\text{C}$ symbol is illuminated in grey. 	<ul style="list-style-type: none"> ▶ If you wish to use the food probe in spite of this, change to the  operating mode menu and set a suitable operating mode.
<ul style="list-style-type: none"> ▪ The food probe or the socket is defective. 	<ul style="list-style-type: none"> ▶ Call Customer Services.

... the control panel steams up

Possible cause	Solution
<ul style="list-style-type: none"> ▪ Steam escaping when using operating modes with steam. 	<p>It is normal for the control panel to steam up temporarily.</p> <ul style="list-style-type: none"> ▶ When closing the appliance door, make sure that it forms a seal all the way round. ▶ If it keeps steaming up, call Customer Services.

... there is a change in the noise of the fan

Possible cause	Solution
<ul style="list-style-type: none"> ▪ Ventilation of cooking space and cooling-down of appliance occur as required. 	<p>This is normal and reduces the energy consumption.</p>

... the appliance makes noises during operation

Possible cause	Solution
<ul style="list-style-type: none"> ▪ The appliance may emit noise when operating (e.g. switching and pumping noises). 	<p>Such noise is normal.</p>

... the clock is not running correctly

Possible cause	Solution
▪ Irregular mains frequency	▶ Switch off the mains synchronization.
▪ Internal pulse generator is imprecise when mains synchronization is switched off.	▶ Call Customer Services.

... the following appears in the display

FX/EXX see operating instructions

FN XXX XXXXXX

Possible cause	Solution
▪ Various situations can lead to an error message.	<ul style="list-style-type: none"> ▶ Cancel the error message by pressing the ⏏ touch button. ▶ Disconnect from the power supply for about 1 minute. ▶ Reconnect the power supply. ▶ If the error appears again, note down the error message in full along with the serial number (FN; see identification plate). ▶ Disconnect from the power supply. ▶ Call Customer Services.

... the following appears in the display

UX/EXX see operating instructions

FN XXX XXXXXX

Possible cause	Solution
▪ An interruption in the power supply.	<ul style="list-style-type: none"> ▶ Cancel the error message by pressing the ⏏ button. ▶ Disconnect from the power supply for about 1 minute. ▶ Reconnect the power supply. ▶ If the error appears again, note down the error message in full along with the serial number (FN; see identification plate). ▶ Disconnect from the power supply. ▶ Call Customer Services.

... the following appears in the display

Please open the appliance door and then close again!

System initialization necessary.

Possible cause	Solution
<ul style="list-style-type: none"> ▪ The appliance door was open for too long. ▪ After the power was disconnected, microwave was selected without the appliance door being opened and closed beforehand. 	<ul style="list-style-type: none"> ▶ Fully open and close the appliance door. <ul style="list-style-type: none"> – The correct functioning of the door lock is checked.

... the following appears in the display

 Residual heat

Do not remove the water tank.

Possible cause	Solution
<ul style="list-style-type: none"> ▪ Water temperature in the boiler is too high. 	<ul style="list-style-type: none"> ▶ Wait for it to cool down (this can take up to 30 minutes). <p>For safety reasons, water is only pumped off when it falls below a certain temperature.</p> <p>The appliance may be used without further ado.</p>

... the following appears in the display

Descaling failed.

Appliance was not descaled.

Possible cause	Solution
<ul style="list-style-type: none"> ▪ Used unsuitable descaler. 	<ul style="list-style-type: none"> ▶ Descale again using the recommended descaler.
<ul style="list-style-type: none"> ▪ Descaling was not carried out correctly. 	<ul style="list-style-type: none"> ▶ If the message does not disappear after repeating the descaling process several times, note down the error message in full and the serial number (FN; see identification plate). ▶ Call Customer Services.

13.2 After a power failure



The user settings remain unchanged.

Brief power failure during operation

- The current operation of the appliance is cancelled.
- The following appears in the display when the appliance is switched on: «Power failure. Operation cancelled».
- ▶ To cancel the message, select ✓.
 - The operating modes menu appears in the display.

Brief power failure during descaling

- The descaling process is interrupted.
- The following appears in the display when the appliance is switched on: « Power failure. Continuing descaling.»
- ▶ To confirm the message, select ✓.
- The descaling process continues.

Prolonged power failure

Variant 1 *

* Depending on the software version

The appliance goes through its initial set-up process after a prolonged power failure. However, only the language and time need to be reset to enable the appliance to be operated again. It is not necessary to make any other settings.

- If a descaling process was running, the descaling process continues.

Variant 2 *

* Depending on the software version

The appliance goes through its initial set-up process after a prolonged power failure. However, only the time needs to be reset to enable the appliance to be operated again. It is not necessary to make any other settings.

- The following appears in the display when the appliance is switched on: «Power failure. Set time.»
- ▶ To confirm the message, select ✓.
- The «Clock» menu in the user settings appears in the display.
- ▶ Select ⌚, set the time and confirm.
- The «Clock» menu appears again in the display.
- ▶ Select ↶.
- The following appears in the display: «Do you want to continue with the initial start-up?»
- ▶ To change other user settings, select «Yes».
- The relevant user settings menu appears in the display.
- ▶ If no other user settings are to be changed, select «No».
- The appliance is ready for operation again.
- If a descaling process was running, the descaling process continues.

14 Accessories and spare parts

The accessories listed below, as well as spare parts, can be ordered in addition to the scope of delivery of the appliance. Ordering is subject to charge, except in the event of warranty claims. Please give product family of the appliance and exact designation of the accessory or spare part when ordering parts.

14.1 Accessories

Stainless steel tray

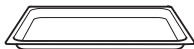

Perforated plastic cooking tray

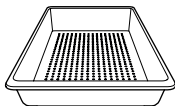

Wire shelf



Dual enamel baking tray



Hardened glass dish



Food probe



EasyCook brochure



Recipe book



14.2 Special accessories

For information see:

www.vzug.com

14.3 Spare parts

Shelf guides
left/right



Knurled nut



Lid for water tank



Water tank

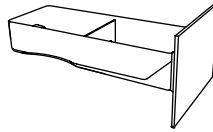

Sealing pad for Vacuisine with food probe

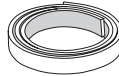
durgol swiss steamer
descaler

The descaler is also available from specialist retailers.

15 Technical data

External dimensions



- ▶ See installation instructions

Electrical connection

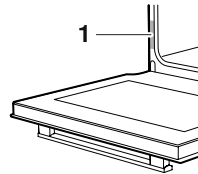
- ▶ See identification plate 1



15.1 Note for testing institutes

The energy efficiency class according to EN 50304 / EN 60350 is determined using the  and  operating modes.

Placing thermocouples between the appliance door and the seal can cause lack of leak-tightness and thus measuring errors.

The usable volume within the meaning of EN 50304 / EN 60350 is obtained with the shelf guides disassembled.

The rated power is determined in accordance with the requirements of IEC 60335 using the «User settings / Check connection» function.

General note

Maximum load capacity: 3 kg

15.2 Temperature measurement

The temperature inside the cooking space is measured when the cooking space is empty according to an internationally accepted standard. Own measurements can be imprecise and are not suitable for checking the accuracy of the temperature.

15.3 Product fiche





In accordance with EU Regulation No.: 66/2014		
Brand	–	V-ZUG Ltd
Type of appliance	–	Steam cooker
Model designation	–	CSTMSLQ
Mass of appliance	kg	52
Number of cavities	–	1
Heat source per cavity	–	Electric
Volume per cavity	l	55
Energy consumption in conventional mode ¹⁾	kWh/cycle	0.79
Energy consumption in hot air / forced convection mode ²⁾	kWh/cycle	0.67
Energy-efficiency index per cavity ³⁾	–	85.9
Measurement and calculation methods used	–	IEC 60350

1) Required to heat a standardized load in cavity

2) Required to heat a standardized load in cavity

3) Measurement methods: See EU Regulation No. 66/2014, Annex II, Chapter 1

Saving energy while cooking

The  and  operating modes consume less energy than the  and  operating modes.

- ▶ Avoid opening the appliance door frequently.
- ▶ For gratins, use the residual heat: for cooking times over 30 minutes, switch the appliance off 5–10 minutes before the end of the operating time.
- ▶ Minimize preheating.
- ▶ Only preheat the cooking space if the cooking or baking results depend on it.

15.4 EcoStandby

To prevent unnecessary energy consumption, the appliance is equipped with the automatic energy-saving «EcoStandby» function.



To reduce power consumption to a minimum, select «Hide time» in the user settings. Despite EcoStandby, all safety functions remain active.

15.5 Reference to «Open Source» licence

Your appliance contains Newlib open-source software. This is subject to the licensing conditions specified in Section 4.1 (4.1.1-4.1.8; 4.1.9; 4.1.10; 4.1.14-4.1.16) of the enclosed open-source software licence text document.

16 Disposal

16.1 Packaging



Never allow children to play with packaging material due to the danger of injury or suffocation. Store the packaging material in a safe location or dispose of it in an environmentally-friendly way.

16.2 Safety

Render the appliance unusable to prevent accidents caused by improper use (e.g. through children playing):

- ▶ Disconnect the appliance from the mains. With a fixed appliance, this is to be carried out by a qualified electrician. Then cut the mains cable off flush with the appliance.

16.3 Disposal



-  The «crossed out wheeled bin» symbol requires the separate collection of waste electrical and electronic equipment (WEEE). Such equipment can contain hazardous, environmentally harmful materials.
- These appliances are to be handed over to a designated collection point for the recycling of electrical and electronic equipment and must not be disposed of with unsorted household waste. And in this way, you will be helping to protect resources and the environment.
- For more information, please contact the local authorities.

17 Index

A	
Accessories	14, 61, 62
Cleaning	54
Acoustic signals	50
Activating/deactivating steam supply	18
Appliance disposal	65
Appliance door	
Cleaning	53
Appliance information	52
Appliance switch-off time	49
B	
Background images	49
BakeOmatic	37
Baking tray	14
Before using for the first time	8
Bottom heat	13, 21
Brightness	49
C	
Cancelling	
Changing recipe	34
Creating own recipe	34
Operating mode	27
Recipes	33
Care	52
Check connection	52
Cleaning	53
Accessories	54
Appliance door	53
Cooking space	53
Door seal	53
Food probe	54
Shelf guides	54
Water tank	54
Cleaning the exterior	53
Clock	50
Combi mode	
with microwave	22
Construction	12
Cooking space	
Cleaning	53
Temperature measurement	63
Cooking tray	15
D	
Defrosting	43
Degree of moisture	42
Delayed start	25
Deleting	
Favourites	46
Own recipe	35
Demo mode	52
Descaler	55
Descaling	54
Duration until next descaling process	52
Failed	60
Rinsing phase	56
Starting	56
Disposal	65
Door seal	
Cleaning	53
Replacing	54
Duration	25
Recipe step	34
E	
EasyCook	44, 62
Food groups	45
EcoStandby	64
Electrical connection	63
End	25
Extending operation	28
External dimensions	63
F	
F and E messages	59
Factory settings	52
Fast heating	21, 51
Automatic switch-on	51
Favourites	46
Changing	46
Creating	46
Deleting	46
Starting	46
FN	52
Food probe	15, 26
Cleaning	54
Food probe temperature	26
Measure only	26
G	
Grill	20
Grill-forced convection	20
H	
Halogen light bulb	54
Hardened glass dish	15
Hold	33
Hot air	17
Hot air humid	21
Hot air with bottom heat	19
Hot air with steaming	17
Hygiene	44

I		Press and go.....	24, 51
Identification plate.....	63	Product family.....	2
Illumination.....	51, 57	Professional baking.....	38
Initial set-up.....	8, 11	Q	
Instruction message.....	50	Quick instructions.....	72
Instructions for use.....	8	R	
K		Recipe book.....	32, 62
Keep warm.....	44	Unlocking.....	32
L		Recipes.....	32
Language.....	49	Action required.....	33
Levels.....	13	Changing.....	34
Load capacity.....	63	Copying.....	34
Long cooking time.....	57	Creating own.....	33
Loudness.....	51	Ending a step before time.....	34
M		Step duration.....	34
Mains synchronization.....	50	RegenerateOmatic.....	42
Maintenance.....	52	Regeneration.....	19, 47
Microwave.....	18, 30	Regeneration time.....	42
Combi mode.....	22	S	
Cookware.....	30	Safety precautions	
Note on use.....	30	Appliance-specific.....	6
Tips.....	31	Before using for the first time.....	8
Model number.....	2, 52	Correct use.....	8
N		General.....	5
Notes.....	69	Saving energy.....	48, 64
O		Service & Support.....	71
Operating and display elements.....	12	Setting the time.....	48
Operating mode		Shelf guides.....	54
Cancelling.....	27	Cleaning.....	54
Changing.....	27	Socket.....	13
Selecting.....	24	Soft roasting.....	39
Operating mode settings.....	24	Default value.....	51
Changing.....	24	Positioning the food probe.....	40
Checking.....	24	Seared.....	40
Operation.....	23	Starting.....	41
Own recipes.....	33	Switching off before time.....	42
Creating.....	33	With steam.....	40
Deleting.....	35	Software versions.....	52
P		Spare parts.....	61, 62
Pause.....	33	Special accessories.....	16, 62
Plate warmer.....	16	Stainless steel tray.....	14
Power failure.....	60	Start screen.....	49
PowerPlus.....	22	Steam.....	16
Overview.....	22	Switching off before time.....	27
Uses.....	22	Symbols.....	5
PowerRegeneration.....	18	T	
PowerSteam.....	18	Target temperature.....	26
Preheating.....	48, 64	Technical data.....	63
		Technical questions.....	71
		Temperature sensor.....	13
		Temperature unit.....	51

Testing institutes	63
Time display.....	50
Time format.....	50
Timer	27
Tips and tricks.....	47
Top/bottom heat.....	17
Top/bottom heat humid.....	20
Touch buttons.....	13
Type.....	2

U

U and E messages.....	59
Uneven browning.....	47
User settings.....	48
Adjusting.....	48
Overview.....	48
Using for the first time.....	11

V

Vacuisine	35
Validity.....	2

W

Warranty extensions.....	71
Water hardness.....	50
Water tank.....	51
Automatic ejection.....	51
Cleaning	54
Emptying.....	30
Filling.....	23
Wellness	43
Wire shelf.....	15

18 Notes

19 Service & Support



The «Troubleshooting» chapter provides valuable information for dealing with minor operating faults. This saves you the time, effort and potential cost of having to call out a service technician.

Information on the V-ZUG warranty can be found at www.vzug.com →Service →Warranty information. Please read this information carefully.

Please register your V-ZUG appliance online immediately at www.vzug.com →Service →Warranty registration. This will allow you to take advantage of the best possible support in the event of a fault in the appliance during the warranty period. You will require the serial number (FN) and appliance designation to complete the registration process. This information can be found on the identification plate for your appliance.

My appliance information:

FN: _____ **Appliance:** _____

Always have this appliance information to hand when you contact V-ZUG. Thank you.

- ▶ Open the appliance door.
 - The identification plate is located on the left-side panel.

Your repair order

At www.vzug.com →Service→Service number you will find the telephone number of your nearest V-ZUG service centre.

Technical questions, accessories, warranty extensions

V-ZUG is happy to help you with any general administrative or technical queries, to take your orders for accessories and spare parts and to inform you about our progressive service agreements.

Quick instructions

Here you will find an overview of key operating information.

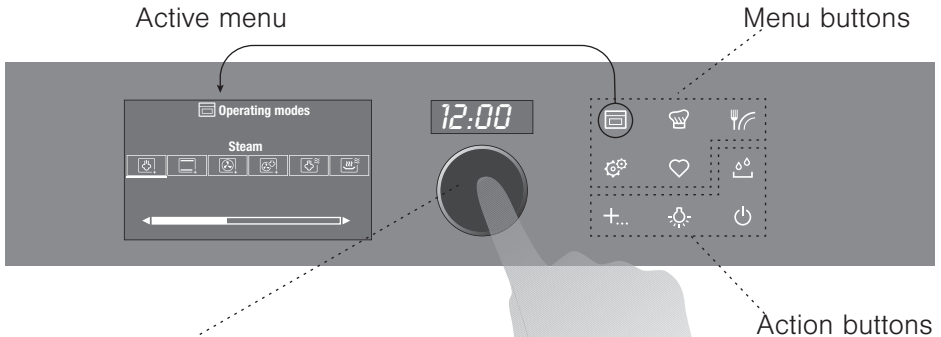



Adjusting knob as a central operating element

- ▶ Press to switch on the appliance or to select/confirm
- ▶ Turn to set the temperature and time or to navigate within the menu

Menu and action buttons

The menu buttons contain a selection of preparation options and user settings. These can be selected by pressing the relevant button. The active menu is shown in the display. You can use the adjusting knob to operate and navigate within the menu; additional submenus can also be called up.

The function buttons provide direct access to independent functions such as illumination  or switching off the appliance .



J23014352-R07

